

VOLTA - MODEL: ADLT25

WAC ARCHITECTURAL

2" Square Recessed Downlight

PROJECT:

TYPE:

Product Image



Line Drawing

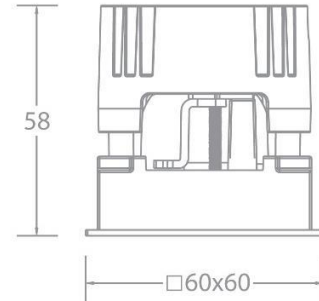

Product Description

VOLTA series LED square narrow-edge recessed downlights have a streamlined appearance and adopt precise lens and black mirror reflector designs to ensure that the light is emitted while still achieving the ultimate anti-glare effect. The light source cavity adopts a sealed design, which can minimize the impact of humid environment on its performance, and the reflector or optical accessories can be freely disassembled and replaced, which greatly improves on-site convenience and is mainly suitable for hotels and commercial indoor places.

Product Features

Product Specifications

- Body Material: Aluminum alloy die-casting
- Optical System: Lens+ SUBOROSA optical system
- Finish: Static electricity powder coating
- Adjustable Angle: /
- Accessories: As attached
- Certification: CCC
- IP Rating: IP20(Light source cavity IP44)
- Insulation Level: Class II
- Operating Temperature: -20°C~40°C

- Cut-out: □55x55mm
- Ceiling Thickness: 1mm~15mm
- Shielding Angle: 30°
- LED Type: HP LED
- Source Lm: 2700K: 682 lm;3000K: 720 lm;3500K: 752 lm; 4000K: 765 lm;5000K: 774 lm
- LED Lifetime: >50000h-L70 /B10-Ta25°C(LM-80/TM-21)
- CCT/CRI: 2700K/3000K/3500K/4000K/5000K, Ra90
- Input: 220V AC / 50Hz
- Dimming: ON-OFF / 0-10V /DALI
- Net Weight: 0.2Kg without packing

Order Model

Model	Size	Trim	LED	Driver	Beam	CCT	Reflector	Finish
ADLT Downlight T series	2 2"	5 Square Trim	LD08 LED 8W	E ON-OFF	1 15°	27 2700K	B Black S Specular	WT White BK Black
				D 0-10V	2 24°	30 3000K		
				N NO DRIVER	3 36°	35 3500K		
				A DALI	5 50°	40 4000K		
						50 5000K		

Example: ADLT25-LD08E230SWT

WAC Lighting
www.waclighting.com (US)
www.waclighting.net (International)

Headquarters
44 Harbor Park Drive • Port Washington, NY
Phone (516) 515.5000 • Fax (516) 515.5050

WAC GROUP
TECHNOLOGY ILLUMINATED

WAC Lighting reserves the right to periodically design and update products. 2025-08-12

VOLTA - MODEL: ADLT25

WAC ARCHITECTURAL

2" Square Recessed Downlight

PROJECT:

TYPE:

Accessories

ALENS-DLT21-BEL
Striped glass lens



ALENS-DLT21-HCL
Honeycomb



Note: A maximum of one optical accessory can be installed. The accessories are not shipped from the factory and need to be ordered separately.

LIGHT DISTRIBUTION@3000K LUMINAIRE DATA

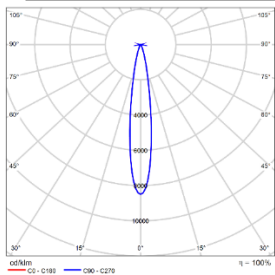

MODEL: ADLT25-LD08E130SWT
BEAM ANGLE: 15 °
POWER: 10W
LUMENS: 397lm
CBCP: 2992cd
EFFICACY: 40lm/W

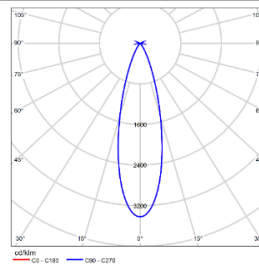

MODEL: ADLT25-LD08E230SWT
BEAM ANGLE: 24 °
POWER: 10W
LUMENS: 455lm
CBCP: 1795cd
EFFICACY: 46lm/W

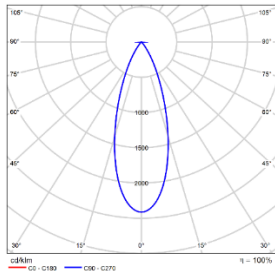

MODEL: ADLT25-LD08E330SWT
BEAM ANGLE: 36 °
POWER: 10W
LUMENS: 445lm
CBCP: 1005cd
EFFICACY: 45lm/W

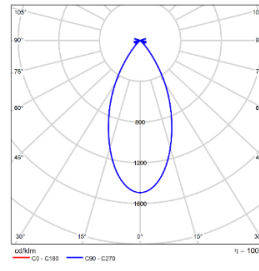

MODEL: ADLT25-LD08E530SWT
BEAM ANGLE: 50 °
POWER: 10W
LUMENS: 302lm
CBCP: 426cd
EFFICACY: 30lm/W

VOLTA - MODEL: ADLT35

3" Square Recessed Downlight

WAC ARCHITECTURAL

PROJECT:

TYPE:

Product Image



Line Drawing

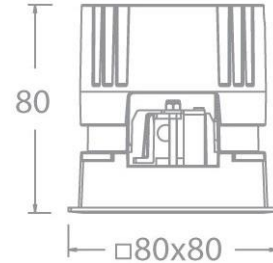

Product Description

VOLTA series LED square narrow-edge recessed downlights have a streamlined appearance and adopt precise lens and black mirror reflector designs to ensure that the light is emitted while still achieving the ultimate anti-glare effect. The light source cavity adopts a sealed design, which can minimize the impact of humid environment on its performance, and the reflector or optical accessories can be freely disassembled and replaced, which greatly improves on-site convenience and is mainly suitable for hotels and commercial indoor places.

Product Features

- Body Material: Aluminum alloy die-casting
- Optical System: Lens+ SUBOROSA optical system
- Finish: Static electricity powder coating
- Adjustable Angle: /
- Accessories: As attached
- Certification: CCC
- IP Rating: IP20(Light source cavity IP44)
- Insulation Level: Class II
- Operating Temperature: -20°C~40°C

Product Specifications

- Cut-out: □75x75mm
- Ceiling Thickness: 1mm~15mm
- Shielding Angle: 30 °
- LED Type: COB
- Source Lm:
 - 2700K: 8W 682lm; 7W 758lm; 10W 1080lm; 13W 1404lm
 - 3000K: 8W 720lm; 7W 800lm; 10W 1150lm; 13W 1495lm
 - 3500K: 8W 752lm; 7W 835lm; 10W 1195lm; 13W 1554lm
 - 4000K: 8W 765lm; 7W 850lm; 10W 1210lm; 13W 1573lm
 - 5000K: 8W 774lm; 7W 860lm; 10W 1220lm; 13W 1586lm
- LED Lifetime: >50000h-L70 /B10-Ta25°C(LM-80/TM-21)
- CCT/CRI: 2700K/3000K/3500K/4000K/5000K, Ra90
- Input: 220V AC / 50Hz
- Dimming: ON-OFF / 0-10V /DALI
- Net Weight: 0.35Kg without packing

Order Model

Model	Size	Trim	LED	Driver	Beam	CCT	Reflector	Finish
ADLT Downlight T series	3 3"	5 Square Trim	LM08 LED 8W	E ON-OFF D 0-10V	S 8°	27 2700K 30 3000K 35 3500K 40 4000K 50 5000K	B Black S Specular	WT White BK Black
			LM07 COB 7W		1 15°			
			LM10 COB 10W		2 24°			
			LM13 COB 13W	3 36°				
			LM13 COB 13W	5 50°				
			N NO DRIVER A DALI					

Example: ADLT35-LM13E230SWT

WAC Lighting
www.waclighting.com (US)
www.waclighting.net (International)

Headquarters
44 Harbor Park Drive • Port Washington, NY
Phone (516) 515.5000 • Fax (516) 515.5050

WAC GROUP
TECHNOLOGY ILLUMINATED

WAC Lighting reserves the right to periodically design and update products. 2025-08-12

VOLTA - MODEL: ADLT35



3" Square Recessed Downlight

WAC ARCHITECTURAL

PROJECT:

TYPE:

Accessories

ALENS-DLT31-BEL Striped glass lens 	ALENS-DLT31-HCL Honeycomb 
--	---

Note: A maximum of one optical accessory can be installed. The accessories are not shipped from the factory and need to be ordered separately.

LIGHT DISTRIBUTION@3000K LUMINAIRE DATA

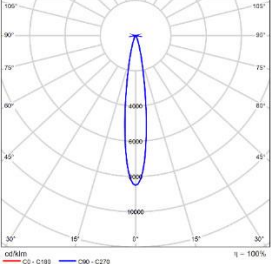
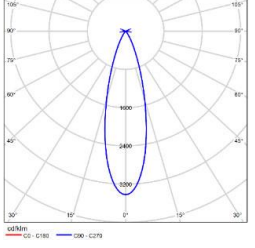
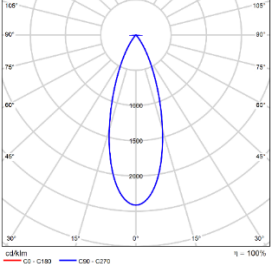
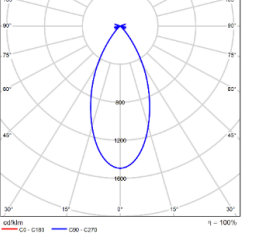
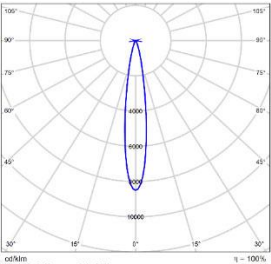
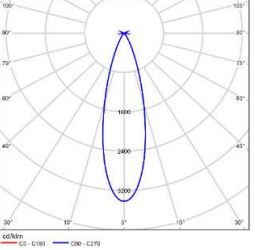
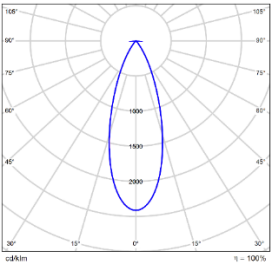
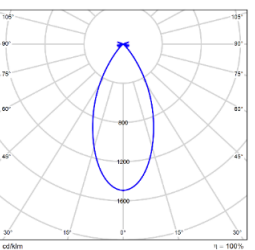
	MODEL: ADLT35-LM07E130SWT BEAM ANGLE: 15 ° POWER: 8W LUMENS: 438lm CBCP: 3725cd EFFICACY: 55lm/W		MODEL: ADLT35-LM07E230SWT BEAM ANGLE: 24 ° POWER: 8W LUMENS: 554lm CBCP: 1894cd EFFICACY: 69lm/W
	MODEL: ADLT35-LM07E330SWT BEAM ANGLE: 36 ° POWER: 8W LUMENS: 456lm CBCP: 1101cd EFFICACY: 57lm/W		MODEL: ADLT35-LM07E530SWT BEAM ANGLE: 50 ° POWER: 8W LUMENS: 378lm CBCP: 565cd EFFICACY: 47lm/W
	MODEL: ADLT35-LM10E130SWT BEAM ANGLE: 15 ° POWER: 11W LUMENS: 542lm CBCP: 4604cd EFFICACY: 49lm/W		MODEL: ADLT35-LM10E230SWT BEAM ANGLE: 24 ° POWER: 11W LUMENS: 685lm CBCP: 2341cd EFFICACY: 62lm/W
	MODEL: ADLT35-LM10E330SWT BEAM ANGLE: 36 ° POWER: 11W LUMENS: 564lm CBCP: 1361cd EFFICACY: 51lm/W		MODEL: ADLT35-LM10E530SWT BEAM ANGLE: 50 ° POWER: 11W LUMENS: 467lm CBCP: 698cd EFFICACY: 42lm/W

VOLTA - MODEL: ADLT35
3" Square Recessed Downlight

WAC ARCHITECTURAL

PROJECT:

TYPE:

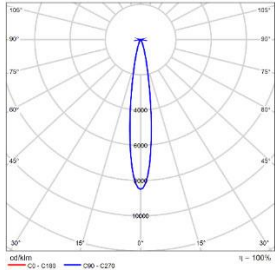

MODEL: ADLT35-LM13E130SWT
BEAM ANGLE: 15 °
POWER: 15W
LUMENS: 710lm
CBCP: 6027cd
EFFICACY: 47lm/W

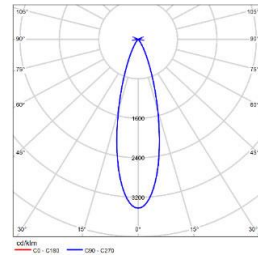

MODEL: ADLT35-LM13E230SWT
BEAM ANGLE: 24 °
POWER: 15W
LUMENS: 896lm
CBCP: 3065cd
EFFICACY: 60lm/W

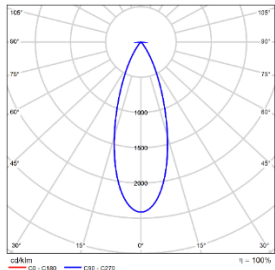

MODEL: ADLT35-LM13E330SWT
BEAM ANGLE: 36 °
POWER: 15W
LUMENS: 738lm
CBCP: 1782cd
EFFICACY: 49lm/W

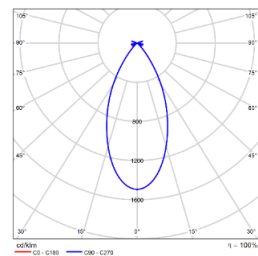

MODEL: ADLT35-LM13E530SWT
BEAM ANGLE: 50 °
POWER: 15W
LUMENS: 612lm
CBCP: 914cd
EFFICACY: 41lm/W

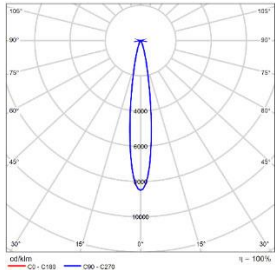

MODEL: ADLT35-LD08ES30SWT
BEAM ANGLE: 8 °
POWER: 11W
LUMENS: 375lm
CBCP: 9280cd
EFFICACY: 34lm/W