

# VOLTA- MODEL: ADDT41

WAC ARCHITECTURAL

## 4" Round Narrow Recessed Downlight

Project Name:

Type:

Product Image



Line Drawing

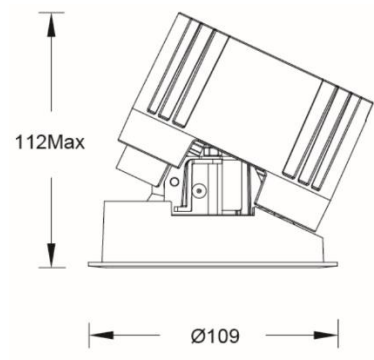

### Product Description

VOLTA series LED round narrow recessed downlight, streamlined appearance, with precise lens and black mirror reflector design. It guarantees light output while still achieving the ultimate anti-glare effect, and the light source cavity is sealed to minimize the impact of humid environment on its performance. Free to remove and replace the reflector or optical accessories, greatly improving the convenience of the site. Mainly suitable for hotel and commercial indoor places.

### Product Features

- **Body Material:** Aluminum die-casting lamp body
- **Optical System:** Lens+Reflector
- **Finish:** Electrostatic powder coating
- **Objection Angle:** /
- **Accessory / Bracket:** See attachment
- **Certification:** CCC
- **IP Rating:** IP20 (light source cavity IP44)
- **Insulation Class:** Class II
- **Operating Temperature:** -20°C~40°C

### Product Specification

- **Cutoff:** Ø100mm
- **Ceiling Thickness:** 1mm~20mm
- **Shading Angle:** 30°
- **LED Type:** COB
- **Source Lm:** 2700K: 8W 685lm; 13W 1380lm; 18W 1860lm  
3000K: 8W 720lm; 13W 1465lm; 18W 1975lm  
3500K: 8W 750lm; 13W 1540lm; 18W 2070lm  
4000K: 8W 765lm; 13W 1600lm; 18W 2155lm  
5000K: 8W 775lm; 13W 1645lm; 18W 2220lm
- **LED Lifetime:** >50000h-L70 /B10-Ta25°C(LM-80/TM-21)
- **CCT/CRI:** 2700K/3000K/3500K/4000K/5000K, CRI≥90
- **Input:** 220V AC / 50Hz
- **Dimming:** No dimming / 0-10V/DALI (must do match test with project site system in advance) .
- **Net Weight:** Approx. 0.6Kg, excluding packaging

### Order Model

Model	Size	Trim	LED	Driver	Beam	CCT	Reflector	Finish
ADDT Downlight Directional T series	4"	1 Round Trim	LD08 LED 8W	E On-Off D 0-10V Dimming	S 8°	27 2700K	B Black	WT White
			LM13 COB 13W		1 15°	30 3000K	S Specular	BK Black
			LM18 COB 18W	2 24°	35 3500K			
			LM18 COB 18W	3 36°	40 4000K			
				N No Driver A DALI	5 50°	50 5000K		

Example: ADDT41-LM18E230SWT

WAC Lighting  
www.waclighting.com (US)  
www.waclighting.net (International)

Headquarters  
44 Harbor Park Drive • Port Washington, NY  
Phone (516) 515.5000 • Fax (516) 515.5050

WAC GROUP  
TECHNOLOGY ILLUMINATED

# VOLTA- MODEL: ADDT41



## 4" Round Narrow Recessed Downlight

WAC ARCHITECTURAL

Project Name:

Type:

### Accessory

<b>ALENS-DDT41-BEL</b> Striped Glass Lens		<b>ALENS-DDT41-HCL</b> Rimless Honeycomb Grid	
--	---	--	---

Note: Up to one additional optical accessory can be installed, the factory does not come with accessories, need to be ordered separately.

### Light Distribution@3000K Data

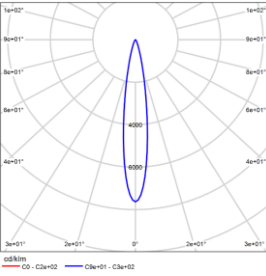
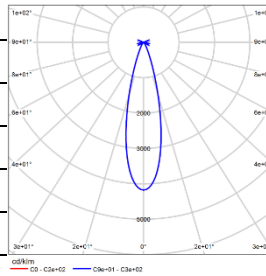
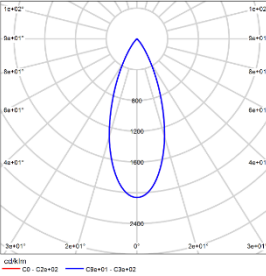
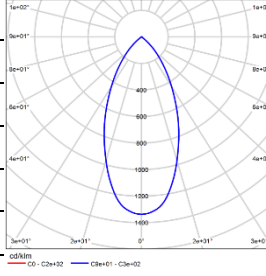
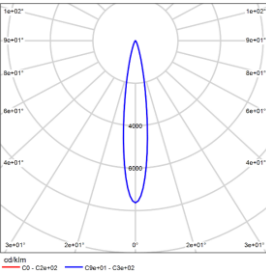
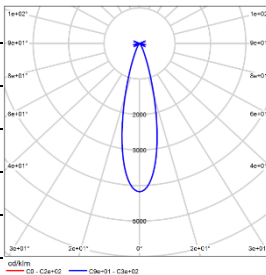
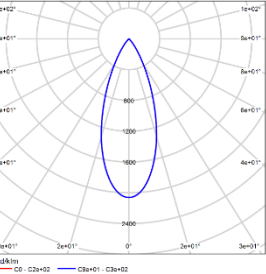
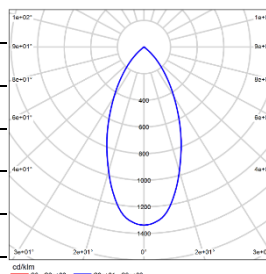
	<b>MODEL:</b> ADDT41-LM13E130SWT <b>BEAM ANGLE:</b> 15° <b>POWER:</b> 15W <b>LUMENS:</b> 884lm <b>CBCP:</b> 6749cd <b>EFFICACY:</b> 59lm/W		<b>MODEL:</b> ADDT41-LM13E230SWT <b>BEAM ANGLE:</b> 24° <b>POWER:</b> 15W <b>LUMENS:</b> 1128lm <b>CBCP:</b> 4708cd <b>EFFICACY:</b> 75lm/W
	<b>MODEL:</b> ADDT41-LM13E330SWT <b>BEAM ANGLE:</b> 36° <b>POWER:</b> 15W <b>LUMENS:</b> 1204lm <b>CBCP:</b> 2482cd <b>EFFICACY:</b> 80lm/W		<b>MODEL:</b> ADDT41-LM13E530SWT <b>BEAM ANGLE:</b> 50° <b>POWER:</b> 15W <b>LUMENS:</b> 995lm <b>CBCP:</b> 1330cd <b>EFFICACY:</b> 66lm/W
	<b>MODEL:</b> ADDT41-LM18E130SWT <b>BEAM ANGLE:</b> 15° <b>POWER:</b> 22W <b>LUMENS:</b> 1258lm <b>CBCP:</b> 9597cd <b>EFFICACY:</b> 57lm/W		<b>MODEL:</b> ADDT41-LM18E230SWT <b>BEAM ANGLE:</b> 24° <b>POWER:</b> 21W <b>LUMENS:</b> 1604lm <b>CBCP:</b> 6695cd <b>EFFICACY:</b> 76lm/W
	<b>MODEL:</b> ADDT41-LM18E330SWT <b>BEAM ANGLE:</b> 36° <b>POWER:</b> 21W <b>LUMENS:</b> 1712lm <b>CBCP:</b> 3529cd <b>EFFICACY:</b> 82lm/W		<b>MODEL:</b> ADDT41-LM18E530SWT <b>BEAM ANGLE:</b> 50° <b>POWER:</b> 21W <b>LUMENS:</b> 1414lm <b>CBCP:</b> 1891cd <b>EFFICACY:</b> 67lm/W

WAC Lighting  
[www.waclighting.com](http://www.waclighting.com) (US)  
[www.waclighting.net](http://www.waclighting.net) (International)

Headquarters  
 44 Harbor Park Drive • Port Washington, NY  
 Phone (516) 515.5000 • Fax (516) 515.5050

WAC GROUP  
 TECHNOLOGY ILLUMINATED

# VOLTA- MODEL: ADDT41

WAC ARCHITECTURAL

## 4" Round Narrow Recessed Downlight

Project Name:

Type:

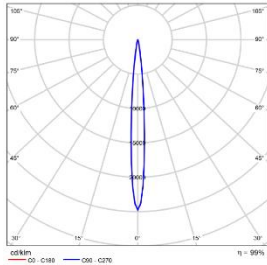

<b>MODEL:</b>	ADDT41-LD08ES30SWT
<b>BEAM ANGLE:</b>	8°
<b>POWER:</b>	11W
<b>LUMENS:</b>	375lm
<b>CBCP:</b>	9280cd
<b>EFFICACY:</b>	34lm/W

# VOLTA- MODEL: ADDT51

## 5" Round Narrow Recessed Downlight

WAC ARCHITECTURAL

Project Name:

Type:

Product Image



Line Drawing

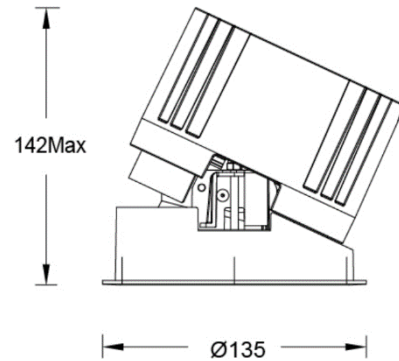

### Product Description

VOLTA series LED round narrow recessed downlight, streamlined appearance, with precise lens and black mirror reflector design. It guarantees light output while still achieving the ultimate anti-glare effect, and the light source cavity is sealed to minimize the impact of humid environment on its performance. Free to remove and replace the reflector or optical accessories, greatly improving the convenience of the site. Mainly suitable for hotel and commercial indoor places.

### Product Features

- **Body Material:** Aluminum die-casting lamp body
- **Optical System:** Lens+Reflector
- **Finish:** Electrostatic powder coating
- **Objection Angle:** /
- **Accessory / Bracket:** See attachment
- **Certification:** CCC
- **IP Rating:** IP20 (light source cavity IP44)
- **Insulation Class:** Class II
- **Operating Temperature:** -20°C~40°C

### Product Specification

- **Cutoff:** Ø125mm
- **Ceiling Thickness:** 1mm~25mm
- **Shading Angle:** 30°
- **LED Type:** COB (of which 8° is HP LED)
- **Source Lm:**  
2700K: 24W 2055lm; 18W 1860lm; 25W 2460lm; 32W 3065lm  
3000K: 24W 2160lm; 18W 1975lm; 25W 2610lm; 32W 3255lm  
3500K: 24W 2250lm; 18W 2070lm; 25W 2710lm; 32W 3380lm  
4000K: 24W 2295lm; 18W 2155lm; 25W 2790lm; 32W 3480lm  
5000K: 24W 2325lm; 18W 2220lm; 25W 2870lm; 32W 3580lm
- **LED Lifetime:** >50000h-L70 /B10-Ta25°C(LM-80/TM-21)
- **CCT/CRI:** 2700K/3000K/3500K/4000K/5000K, CRI≥90
- **Input:** 220V AC / 50Hz
- **Dimming:** No dimming / 0-10V/DALI (must do match test with project site system in advance) .
- **Net Weight:** Approx. 1.0Kg, excluding packaging

### Order Model

Model	Size	Trim	LED	Driver	Beam	CCT	Reflector	Finish
ADDT Downlight Directional T series	5 5"	1 Round Trim	LD24 LED 24W	E On-Off D 0-10V Dimming	S 8°	27 2700K	B Black	WT White
			LM18 COB 18W		1 15°	30 3000K	S Specular	BK Black
			LM25 COB 25W		2 24°	35 3500K		
			LM32 COB 32W	3 36°	40 4000K			
			LM32 COB 32W	5 50°	50 5000K			
				N No Driver A DALI				

Example: ADDT51-LM25E230SWT

WAC Lighting  
www.waclighting.com (US)  
www.waclighting.net (International)

Headquarters  
44 Harbor Park Drive • Port Washington, NY  
Phone (516) 515.5000 • Fax (516) 515.5050

WAC GROUP  
TECHNOLOGY ILLUMINATED

# VOLTA- MODEL: ADDT51



## 5" Round Narrow Recessed Downlight

WAC ARCHITECTURAL

Project Name:

Type:

### Accessory

<b>ALENS-DDT51-BEL</b> Striped Glass Lens		<b>ALENS-DDT51-HCL</b> Rimless Honeycomb Grid	
--	---	--	---

Note: Up to one additional optical accessory can be installed, the factory does not come with accessories, need to be ordered separately.

### Light Distribution@3000K Data

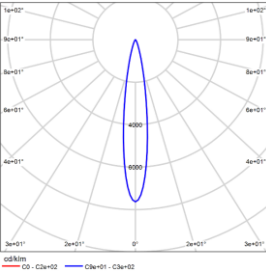
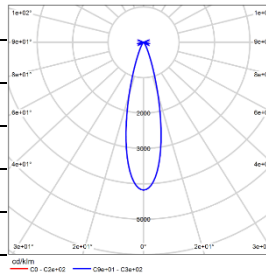
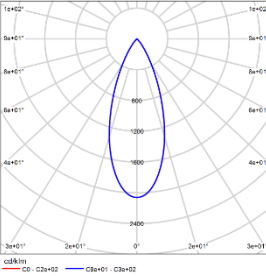
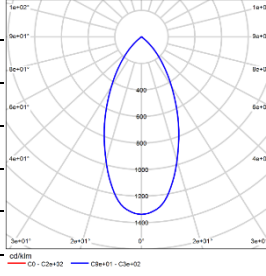
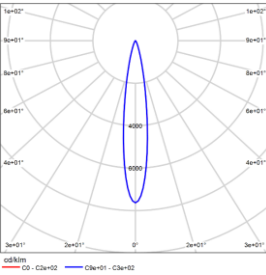
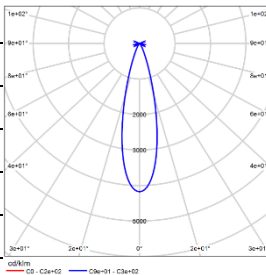
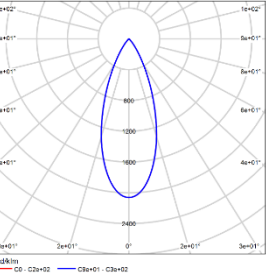
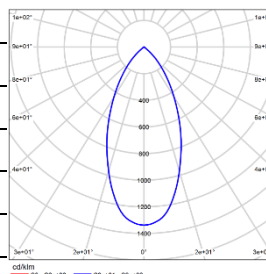
	<b>MODEL:</b> ADDT51-LM18E130SWT <b>BEAM ANGLE:</b> 15° <b>POWER:</b> 21W <b>LUMENS:</b> 1609lm <b>CBCP:</b> 14044cd <b>EFFICACY:</b> 77lm/W		<b>MODEL:</b> ADDT51-LM18E230SWT <b>BEAM ANGLE:</b> 24° <b>POWER:</b> 21W <b>LUMENS:</b> 1640lm <b>CBCP:</b> 6742cd <b>EFFICACY:</b> 78lm/W
	<b>MODEL:</b> ADDT51-LM18E330SWT <b>BEAM ANGLE:</b> 36° <b>POWER:</b> 21W <b>LUMENS:</b> 1783lm <b>CBCP:</b> 3738cd <b>EFFICACY:</b> 85lm/W		<b>MODEL:</b> ADDT51-LM18E530SWT <b>BEAM ANGLE:</b> 50° <b>POWER:</b> 21W <b>LUMENS:</b> 1538lm <b>CBCP:</b> 2311cd <b>EFFICACY:</b> 73lm/W
	<b>MODEL:</b> ADDT51-LM25E130SWT <b>BEAM ANGLE:</b> 15° <b>POWER:</b> 28W <b>LUMENS:</b> 2111lm <b>CBCP:</b> 18431cd <b>EFFICACY:</b> 75lm/W		<b>MODEL:</b> ADDT51-LM25E230SWT <b>BEAM ANGLE:</b> 24° <b>POWER:</b> 28W <b>LUMENS:</b> 2152lm <b>CBCP:</b> 8848cd <b>EFFICACY:</b> 77lm/W
	<b>MODEL:</b> ADDT51-LM25E330SWT <b>BEAM ANGLE:</b> 36° <b>POWER:</b> 28W <b>LUMENS:</b> 2340lm <b>CBCP:</b> 4905cd <b>EFFICACY:</b> 84lm/W		<b>MODEL:</b> ADDT51-LM25E530SWT <b>BEAM ANGLE:</b> 50° <b>POWER:</b> 28W <b>LUMENS:</b> 2018lm <b>CBCP:</b> 3033cd <b>EFFICACY:</b> 72lm/W

WAC Lighting  
[www.waclighting.com](http://www.waclighting.com) (US)  
[www.waclighting.net](http://www.waclighting.net) (International)

Headquarters  
 44 Harbor Park Drive • Port Washington, NY  
 Phone (516) 515.5000 • Fax (516) 515.5050

WAC GROUP  
 TECHNOLOGY ILLUMINATED

**5" Round Narrow Recessed Downlight**

**Project Name:**

**Type:**

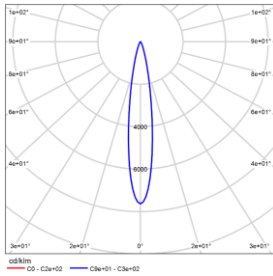

**MODEL:** ADDT51-LM32E130SWT  
**BEAM ANGLE:** 15°  
**POWER:** 35W  
**LUMENS:** 2630lm  
**CBCP:** 22965cd  
**EFFICACY:** 75lm/W

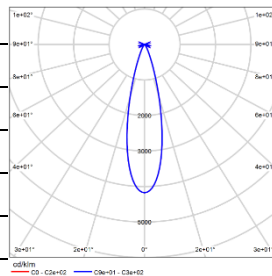

**MODEL:** ADDT51-LM32E230SWT  
**BEAM ANGLE:** 24°  
**POWER:** 35W  
**LUMENS:** 2682lm  
**CBCP:** 11024cd  
**EFFICACY:** 77lm/W

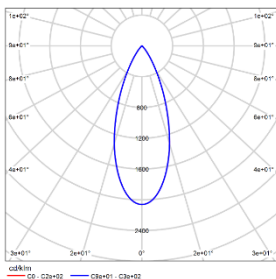

**MODEL:** ADDT51-LM32E330SWT  
**BEAM ANGLE:** 36°  
**POWER:** 35W  
**LUMENS:** 2916lm  
**CBCP:** 6112cd  
**EFFICACY:** 83lm/W

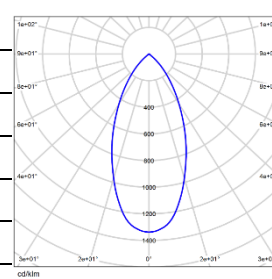

**MODEL:** ADDT51-LM32E530SWT  
**BEAM ANGLE:** 50°  
**POWER:** 35W  
**LUMENS:** 2514lm  
**CBCP:** 3779cd  
**EFFICACY:** 72lm/W

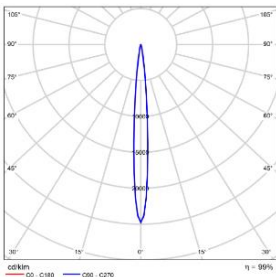

**MODEL:** ADDT51-LD24ES30SWT  
**BEAM ANGLE:** 8°  
**POWER:** 28W  
**LUMENS:** 1125lm  
**CBCP:** 27840cd  
**EFFICACY:** 40lm/W

# VOLTA- MODEL: ADDT61

## 6" Round Narrow Recessed Downlight

WAC ARCHITECTURAL

Project Name:

Type:

Product Image



Line Drawing

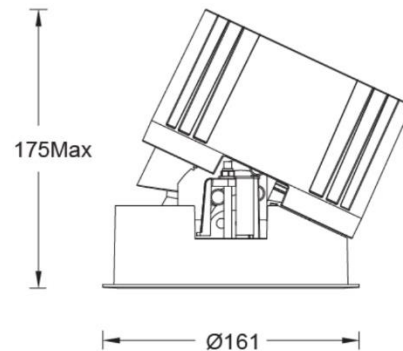

### Product Description

VOLTA series LED round narrow recessed downlight, streamlined appearance, with precise lens and black mirror reflector design. It guarantees light output while still achieving the ultimate anti-glare effect, and the light source cavity is sealed to minimize the impact of humid environment on its performance. Free to remove and replace the reflector or optical accessories, greatly improving the convenience of the site. Mainly suitable for hotel and commercial indoor places.

### Product Features

- **Body Material:** Aluminum die-casting lamp body
- **Optical System:** Lens+Reflector
- **Finish:** Electrostatic powder coating
- **Objection Angle:** /
- **Accessory / Bracket:** See attachment
- **Certification:** CCC
- **IP Rating:** IP20 (light source cavity IP44)
- **Insulation Class:** Class II
- **Operating Temperature:** -20°C~40°C

### Product Specification

- **Cutoff:** Ø150mm
- **Ceiling Thickness:** 1mm~30mm
- **Shading Angle:** 30°
- **LED Type:** COB (of which 8° is HP LED)
- **Source Lm:** 2700K: 32W 2740lm; 32W 3610lm; 43W 4250lm  
3000K: 32W 2880lm; 32W 3830lm; 43W 4505lm  
3500K: 32W 3000lm; 32W 4020lm; 43W 4730lm  
4000K: 32W 3060lm; 32W 4180lm; 43W 4920lm  
5000K: 32W 3100lm; 32W 4310lm; 43W 5065lm
- **LED Lifetime:** >50000h-L70 /B10-Ta25°C(LM-80/TM-21)
- **CCT/CRI:** 2700K/3000K/3500K/4000K/5000K, CRI≥90
- **Input:** 220V AC / 50Hz
- **Dimming:** No dimming / 0-10V/DALI (must do match test with project site system in advance) .
- **Net Weight:** Approx. 1.7Kg, excluding packaging

### Order Model

Model	Size	Trim	LED	Driver	Beam	CCT	Reflector	Finish
ADDT Downlight Directional T series	6 6"	1 Round Trim	LD32 LED 32W	E On-Off D 0-10V Dimming	S 8°	27 2700K	B Black S Specular	WT White
			LM32 COB 32W		1 15°	30 3000K		BK Black
			LM43 COB 43W	2 24°	35 3500K			
			LM43 COB 43W	3 36°	40 4000K			
				N No Driver A DALI	5 50°	50 5000K		

Example: ADDT61-LM43E230SWT

WAC Lighting  
www.waclighting.com (US)  
www.waclighting.net (International)

Headquarters  
44 Harbor Park Drive • Port Washington, NY  
Phone (516) 515.5000 • Fax (516) 515.5050

WAC GROUP  
TECHNOLOGY ILLUMINATED

# VOLTA- MODEL: ADDT61

## 6" Round Narrow Recessed Downlight

WAC ARCHITECTURAL

Project Name:

Type:

### Accessory

<b>ALENS-DDT61-BEL</b> Striped Glass Lens		<b>ALENS-DDT61-HCL</b> Rimless Honeycomb Grid	
--	---	--	---

Note: Up to one additional optical accessory can be installed, the factory does not come with accessories, need to be ordered separately.

### Light Distribution@3000K Data

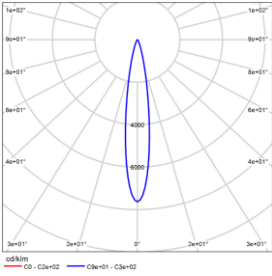
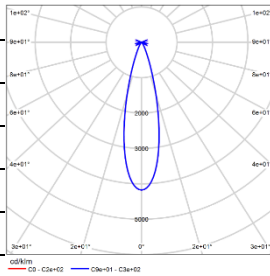
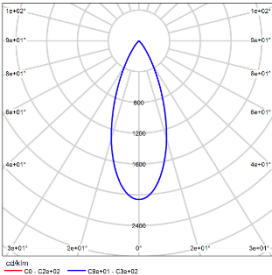
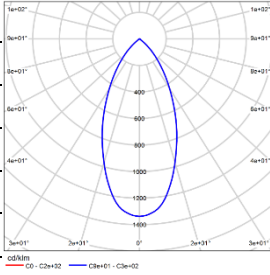
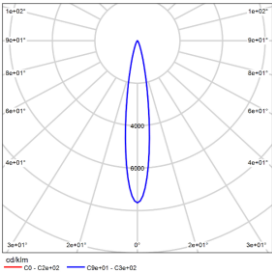
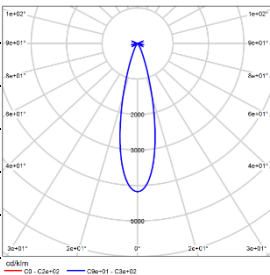
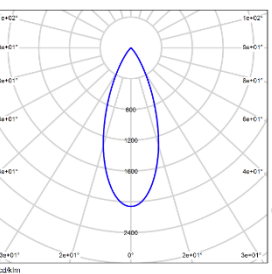
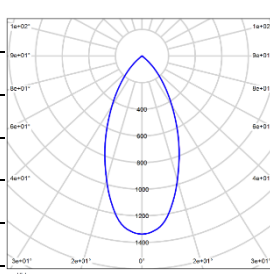
	<b>MODEL:</b> ADDT61-LM32E130SWT <b>BEAM ANGLE:</b> 15° <b>POWER:</b> 35W <b>LUMENS:</b> 2393lm <b>CBCP:</b> 23635cd <b>EFFICACY:</b> 68lm/W		<b>MODEL:</b> ADDT61-LM32E230SWT <b>BEAM ANGLE:</b> 24° <b>POWER:</b> 35W <b>LUMENS:</b> 3015lm <b>CBCP:</b> 13170cd <b>EFFICACY:</b> 86lm/W
	<b>MODEL:</b> ADDT61-LM32E330SWT <b>BEAM ANGLE:</b> 36° <b>POWER:</b> 35W <b>LUMENS:</b> 3001lm <b>CBCP:</b> 6651cd <b>EFFICACY:</b> 86lm/W		<b>MODEL:</b> ADDT61-LM32E530SWT <b>BEAM ANGLE:</b> 50° <b>POWER:</b> 35W <b>LUMENS:</b> 2830lm <b>CBCP:</b> 3762cd <b>EFFICACY:</b> 81lm/W
	<b>MODEL:</b> ADDT61-LM43E130SWT <b>BEAM ANGLE:</b> 15° <b>POWER:</b> 47W <b>LUMENS:</b> 3108lm <b>CBCP:</b> 30695cd <b>EFFICACY:</b> 66lm/W		<b>MODEL:</b> ADDT61-LM43E230SWT <b>BEAM ANGLE:</b> 24° <b>POWER:</b> 47W <b>LUMENS:</b> 3916lm <b>CBCP:</b> 17104cd <b>EFFICACY:</b> 83lm/W
	<b>MODEL:</b> ADDT61-LM43E330SWT <b>BEAM ANGLE:</b> 36° <b>POWER:</b> 47W <b>LUMENS:</b> 3897lm <b>CBCP:</b> 8638cd <b>EFFICACY:</b> 83lm/W		<b>MODEL:</b> ADDT61-LM43E530SWT <b>BEAM ANGLE:</b> 50° <b>POWER:</b> 47W <b>LUMENS:</b> 3675lm <b>CBCP:</b> 4885cd <b>EFFICACY:</b> 78lm/W

WAC Lighting  
[www.waclighting.com](http://www.waclighting.com) (US)  
[www.waclighting.net](http://www.waclighting.net) (International)

Headquarters  
 44 Harbor Park Drive • Port Washington, NY  
 Phone (516) 515.5000 • Fax (516) 515.5050

WAC GROUP  
 TECHNOLOGY ILLUMINATED

**VOLTA** - MODEL: ADDT61  
6" Round Narrow Recessed Downlight

WAC ARCHITECTURAL

Project Name:

Type:

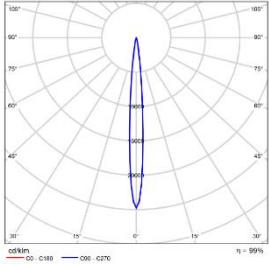

**MODEL:** ADDT61-LD32ES30SWT  
**BEAM ANGLE:** 8°  
**POWER:** 35W  
**LUMENS:** 1500lm  
**CBCP:** 37120cd  
**EFFICACY:** 43lm/W