

SWALLOW III - MODEL: ATL41HLM

WAC ARCHITECTURAL

W Track Luminaires

PROJECT:

TYPE:

Product Image



Line Drawing

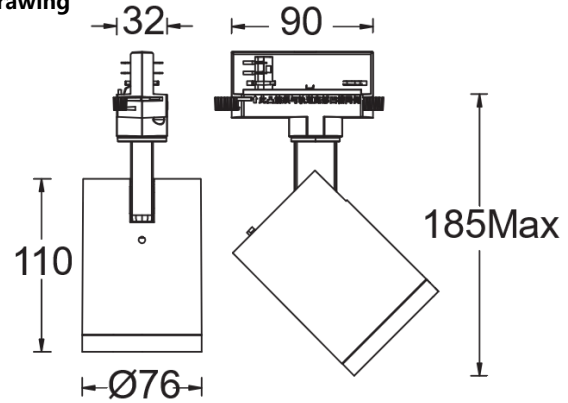

Product Description

SWALLOW III Series LED Track Spotlight

Designed for W three-circuit track systems, the SWALLOW III series features a refined profile with a die-cast aluminum housing and a clean look without visible heat sinks. Equipped with a high-power COB light engine, it offers a wide range of color temperatures, excellent color rendering options, and multiple beam angles. Interchangeable optical accessories can be replaced by hand without tools. Ideal for museums, galleries, exhibition halls, premium retail, and residential spaces.

Product Features

- Body Material: Die-cast aluminum body with an insulated, high-voltage-resistant plastic electrical box
- Optical System: Lens+zoom lens
- Finish: Static electricity powder coating, BK/WT
- Adjustable Angle: Horizontal 0~365°, Vertical 0-90°
- Accessories: See accessories table for details
- Certification: CCC
- IP Rating: IP20
- Insulation Level: Class I
- Operating Temperature: -20°C~40°C
- Product Weight: Approx. 0.7 kg (excluding packaging)

Product Specifications

- LED Type: COB
- LED Source Power: ATL41HLM09(1x9W)/ATL41HLM12(1x12W)
- Source Lm:
3000K: 950lm (1x9W)/1270lm (1x12W)
3500K: 960lm (1x9W)/1278lm (1x12W)
4000K: 980lm (1x9W)/1290lm (1x12W)
- LED Lifetime: > 50000h-L70/B10-Ta25°C(LM-80/TM-21)
- CCT/CRI: 3000K/3500K/4000K, Ra90/Ra97(≥Ra95)
- SDCM: 2 SDCM
- Input: 220V~240V AC/50Hz
- Dimming: Built-in 3-circuit rotary dimming(10%~100%)

Built-in 4-wire single-circuit rotary + 0-10V2-in-1 dimming, DALI(compatibility testing with the project site required in advance)

Ordering model

Model	LED	Dimming	Beam	CRI	CCT	Finish
ATL41H SWALLOW III	LM09	O On-board D 0-10V+On-board A DALI	1 15°	9 90 A 97	30 3000K 35 3500K 40 4000K	WT White BK Black
	LM12		2 24°			

Example: ATL41HLM12-O2930WT

WAC Lighting
www.waclighting.com (US)
www.waclighting.net (International)

Headquarters
44 Harbor Park Drive • Port Washington, NY
Phone (516) 515.5000 • Fax (516) 515.5050

WAC GROUP
TECHNOLOGY ILLUMINATED

WAC Lighting reserves the right to periodically design and update products. 2025-08-12

SWALLOW III - MODEL: ATL41HLM











WAC ARCHITECTURAL

W Track Luminaires

PROJECT:

TYPE:

Accessories

First class fittings	lens(WT) "angle 1" LENS-ATL42-01WT lens(BK) "angle 1" LENS-ATL42-01BK		lens(WT) "angle 2" LENS-ATL42-02WT lens(BK) "angle 2" LENS-ATL42-02BK		lens(WT) "angle 3" LENS-ATL42-03WT lens(BK) "angle 3" LENS-ATL42-03BK	
	lens(WT) "angle 5" LENS-ATL42-05WT lens(BK) "angle 5" LENS-ATL42-05BK		lens(WT) "angle W" LENS-ATL42-WWWT lens(BK) "angle W" LENS-ATL42-WWBK		lens(WT) "angle E" LENS-ATL42-EEWT lens(BK) "angle E" LENS-ATL42-EEBK	
	lens(WT) "angle G" LENS-ATL42-GGWT lens(BK) "angle G" LENS-ATL42-GGBK		Integrated anti-glare honeycomb module(WT) LENS-ATL42HCM-WT Integrated anti-glare honeycomb module(BK) LENS-ATL42HCM-BK			
Second class fittings	Integrated snoot(WT) LENS-ATL42-SNT-WT Integrated snoot(BK) LENS-ATL42-SNT-BK		four-leaf sunshade(WT) LENS-ATL42-BD-WT four-leaf sunshade(BK) LENS-ATL42-BD-BK			
Third class fittings	Safety rope(WT) PART-ATL4ROPE-WT Safety rope(BK) PART-ATL4ROPE-BK					

Note:

First class fittings and second class fittings can be stacked; it is recommended to install no more than three optical accessories. Third class fittings (ATL41H/ATL42H) must be ordered separately, ATL43H is included by default.

SWALLOW III - MODEL: ATL42HLM

WAC ARCHITECTURAL

W Track Luminaires

PROJECT:

TYPE:

Product Image



Line Drawing

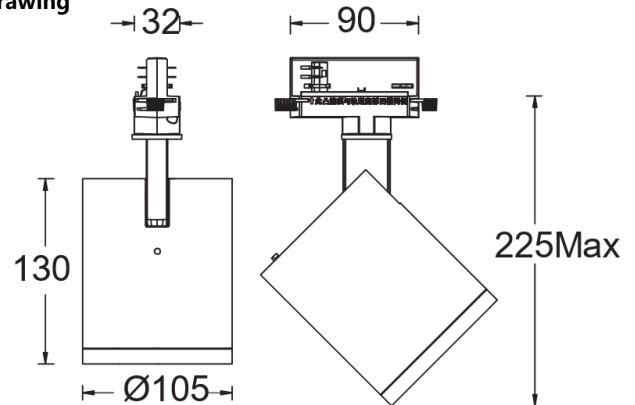

Product Description

SWALLOW III Series LED Track Spotlight

Designed for W three-circuit track systems, the SWALLOW III series features a refined profile with a die-cast aluminum housing and a clean look without visible heat sinks. Equipped with a high-power COB light engine, it offers a wide range of color temperatures, excellent color rendering options, and multiple beam angles. Interchangeable optical accessories can be replaced by hand without tools. Ideal for museums, galleries, exhibition halls, premium retail, and residential spaces.

Product Features

- Body Material: Die-cast aluminum housing with an insulated, high-voltage-resistant plastic electrical box
- Optical System: Lens+zoom lens
- Finish: Static electricity powder coating, BK/WT
- Adjustable Angle: Horizontal 0~365°, Vertical 0-90°
- Accessories: See accessories table for details
- Certification: CCC
- IP Rating: IP20
- Insulation Level: Class I
- Operating Temperature: -20°C~40°C
- Product Weight: Approx.1.3kg (excluding packaging)

Product Specifications

- LED Type: COB
- LED SourcePower: ATL41HLM12(1x12W)/ATL41HLM18(1x18W)/ATL41HLM25(1x25W)
- Source Lm:
3000K: 1420lm(1x12W)/2120lm (1x18W)/2690lm (1x25W)
3500K: 1490lm(1x12W)/2230lm (1x18W)/2730lm (1x25W)
4000K: 1560lm(1x12W)/2330lm (1x18W)/2880lm (1x25W)
- LED Lifetime: > 50000h-L70/B10-Ta25°C(LM-80/TM-21)
- CCT/CRI: 3000K/3500K/4000K, Ra90/Ra97(≥Ra95)
- SDCM: 2 SDCM
- Input: 220V~240V AC/50Hz
- Dimming: Built-in 3-circuit rotary dimming (10%–100%)
Built-in 4-wire single-circuit rotary + 0–10V 2-in-1 dimming, DALI (compatibility testing with the project site required in advance)

Order Model

Model	LED	Dimming	Beam	CRI	CCT	Finish
ATL42H SWALLOW III	LM12 LM18 LM25	O On-board D 0-10V+On-board A DALI	1 15°	9 90 A 97	30 3000K 35 3500K 40 4000K	WT White BK Black
			2 24°			
			3 36°			
			5 55°			
			E 15*55°			
			G 25*55°			
			W Wall Washer			

Example: ATL42HLM25-O2930WT

WAC Lighting
www.waclighting.com (US)
www.waclighting.net (International)

Headquarters
44 Harbor Park Drive • Port Washington, NY
Phone (516) 515.5000 • Fax (516) 515.5050

WAC GROUP
TECHNOLOGY ILLUMINATED

SWALLOW III - MODEL: ATL42HLM











WAC ARCHITECTURAL

W Track Luminaires

PROJECT:

TYPE:

Accessories

First class fittings	lens(WT) "angle 1" LENS-ATL42-01WT lens(BK) "angle 1" LENS-ATL42-01BK		lens(WT) "angle 2" LENS-ATL42-02WT lens(BK) "angle 2" LENS-ATL42-02BK		lens(WT) "angle 3" LENS-ATL42-03WT lens(BK) "angle 3" LENS-ATL42-03BK	
	lens(WT) "angle 5" LENS-ATL42-05WT lens(BK) "angle 5" LENS-ATL42-05BK		lens(WT) "angle W" LENS-TL42-WWWT lens(BK) "angle W" LENS-TL42-WWBK		lens(WT) "angle E" LENS-ATL42-EEWT lens(BK) "angle E" LENS-ATL42-EEBK	
	lens(WT) "angle G" LENS-ATL42-GGWT lens(BK) "angle G" LENS-ATL42-GGBK		Integrated anti-glare honeycomb module(WT) LENS-ATL42HCM-WT Integrated anti-glare honeycomb module(BK) LENS-ATL42HCM-BK			
Second class fittings	Integrated snoot(WT) LENS-ATL41-SNT-WT Integrated snoot(BK) LENS-ATL41-SNT-BK		four-leaf sunshade(WT) LENS-ATL41-BD-WT four-leaf sunshade(BK) LENS-ATL41-BD-BK			
Third class fittings	Safety rope(WT) PART-ATL4ROPE-WT Safety rope(BK) PART-ATL4ROPE-BK					

Note:

First class fittings and second class fittings can be stacked; it is recommended to install no more than three optical accessories. Third class fittings (ATL41H/ATL42H) must be ordered separately, ATL43H is included by default.

SWALLOW III - MODEL: ATL43HLM

WAC ARCHITECTURAL

W Track Luminaires

PROJECT:

TYPE:

Product Image



Line Drawing

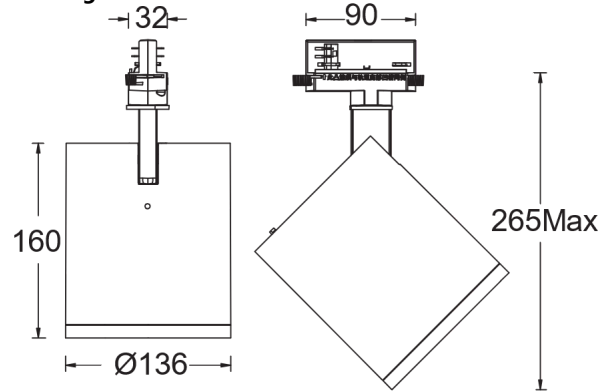

Product Description

SWALLOW III Series LED Track Spotlight

Designed for W three-circuit track systems, the SWALLOW III series features a refined profile with a die-cast aluminum housing and a clean look without visible heat sinks. Equipped with a high-power COB light engine, it offers a wide range of color temperatures, excellent color rendering options, and multiple beam angles. Interchangeable optical accessories can be replaced by hand without tools. Ideal for museums, galleries, exhibition halls, premium retail, and residential spaces.

Product Features

- Body Material: Die-cast aluminum housing with an insulated, high-voltage-resistant plastic electrical box
- Optical System: Lens+zoom lens
- Finish: Static electricity powder coating, BK/WT
- Adjustable Angle: Horizontal 0~365°, Vertical 0-90°
- Accessories: See accessories table for details
- Certification: CCC
- IP Rating: IP20
- Insulation Level: Class I
- Operating Temperature: -20°C~40°C
- Product Weight: Approx: 1.3kg (excluding packaging)

Product Specifications

- LED Type: COB
- LED Source Power: ATL41HLM24(1x24W)/ATL41HLM32(1x32W)/ATL41HLM40(1x40W)
- Source Lm:
3000K: 1420lm (1x24W)/1420lm (1x32W)/4120lm(1x40W)
3500K: 1490lm (1x24W)/1490lm (1x32W)/4190lm(1x40W)
4000K: 1560lm (1x24W)/1560lm (1x32W)/4250lm(1x40W)
- LED Lifetime: >50000h-L70/B10-Ta25°C(LM-80/TM-21)
- CCT/CRI: 3000K/3500K/4000K, Ra90/Ra97(≥Ra95)
- SDCM: 2 SDCM
- Input: 220V~240V AC/50Hz
- Dimming: Built-in 3-circuit rotary dimming (10%–100%)
Built-in 4-wire single-circuit rotary + 0–10V 2-in-1 dimming, DALI (compatibility testing with the project site required in advance)

Order Model

Model	LED	Dimming	Beam	CRI	CCT	Finish
ATL43H SWALLOW III	LM24 LM32 LM40	O On-board D 0-10V+On-board A DALI	1 15°	9 90 A 97	30 3000K 35 3500K 40 4000K	WT White BK Black
			2 24°			
			3 36°			
			5 55°			
			E 15*55°			
			G 25*55°			
			W Wall Washer			

Example: ATL43HLM32-O2930WT

WAC Lighting
www.waclighting.com (US)
www.waclighting.net (International)

Headquarters
44 Harbor Park Drive • Port Washington, NY
Phone (516) 515.5000 • Fax (516) 515.5050

WAC GROUP
TECHNOLOGY ILLUMINATED

WAC Lighting reserves the right to periodically design and update products. 2025-08-12

SWALLOW III - MODEL: ATL43HLM











WAC ARCHITECTURAL

W Track Luminaires

PROJECT:

TYPE:

Accessories

First class fittings	lens(WT) "angle 1" LENS-ATL41-01WT lens(BK) "angle 1" LENS-ATL41-01BK 	lens(WT) "angle 2" LENS-ATL41-02WT lens(BK) "angle 2" LENS-ATL41-02BK 	lens(WT) "angle 3" LENS-ATL41-03WT lens(BK) "angle 3" LENS-ATL41-03BK 	
	lens(WT) "angle 5" LENS-ATL41-05WT lens(BK) "angle 5" LENS-ATL41-05BK 	lens(WT) "angle W" LENS-ATL41-WWWT lens(BK) "angle W" LENS-ATL41-WWBK 	lens(WT) "angle E" LENS-ATL41-EEWT lens(BK) "angle E" LENS-ATL41-EEBK 	
	lens(WT) "angle G" LENS-ATL41-GGWT lens(BK) "angle G" LENS-ATL41-GGBK 	Integrated anti-glare honeycomb module(WT) LENS-ATL41HCM-WT Integrated anti-glare honeycomb module(BK) LENS-ATL41HCM-BK 		
Second class fittings	Integrated snoot(WT) LENS-ATL41-SNT-WT Integrated snoot(BK) LENS-ATL41-SNT-BK 	four-leaf sunshade(WT) LENS-ATL41-BD-WT four-leaf sunshade(BK) LENS-ATL41-BD-BK 		
Third class fittings	Safety rope(WT) PART-ATL4ROPE-WT Safety rope(BK) PART-ATL4ROPE-BK 			

Note:

First class fittings and second class fittings can be stacked; it is recommended to install no more than three optical accessories. Third class fittings (ATL41H/ATL42H) must be ordered separately, ATL43H is included by default.