

Recessed Ceiling Luminaires

PROJECT

TYPE

Product Image



Line Drawing

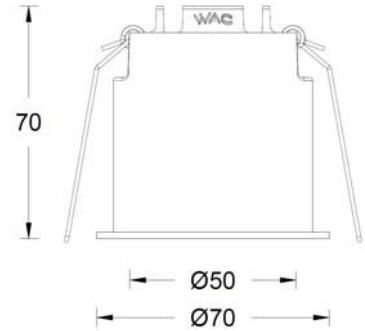

Product Description

The LANNE PRO lower lighting tube lamp is exquisite and simple, with precise light distribution. It adopts SUBROSA hidden light technology and has the ultimate anti glare effect. Mainly suitable for hotels and commercial public spaces.

Product Features

- Body Material: Aluminum alloy die-casting
- Optical System: Lens +Subrosa hidden light system
- Finish: Electrostatic powder coating,
- Adjustable Angle: /
- Accessories: /
- Certification: CCC
- IP Rating: IP65
- Insulation Level: Class I
- Operating Temperature: -20°C~50°C

Product Specifications

- Opening: Ø63mm
- Ceiling: 1mm~25mm
- Light: 35°
- Light source type: High Power LED
- Source Lm: 800lm
- LED Lifetime: >50000h-L70/B10-Ta25°C(LM-80/TM-21)
- CCT/CRI: 2700K/ 3000K/ 4000K , Ra90
- SDCM: 3 SDCM (4000K 5SDCM)
- Input: 220V~240V AC / 50Hz
- Dimming: No dimming/0-10V dimming
- Net Weight: 0.5Kg without packing

Order Model

Model	Height	Frame	Power	Options	Color	Finish	
59F&) 2"	= Frame	' 8 8W	<CON-OFF 220V AC Power Supply ; C0-10V Dimming 220V AC Power Supply	(15°) 2700K * 24° 3000K * 36° + 48° 4000K	9 Black J Speculr	NK White

Example: AER22F-08EL127BWT

Recessed Ceiling Luminaires

PROJECT :

TYPE :

LIGHT DISTRIBUTION@3000K LUMINAIRE DATA

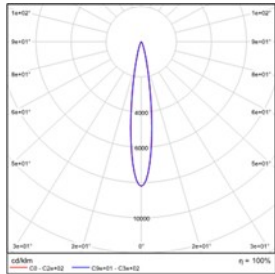

MODEL	CER22F-08EL130BWT
BEAM ANGLE	15 _°
POWER	10W
LUMENS	480LM
CBCP	5810CD
EFFICACY	48LM/W

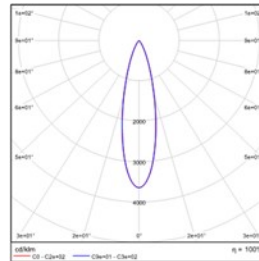

MODEL	CER22F-08EL230BWT
BEAM ANGLE	24 _°
POWER	10W
LUMENS	470LM
CBCP	2342CD
EFFICACY	47LM/W

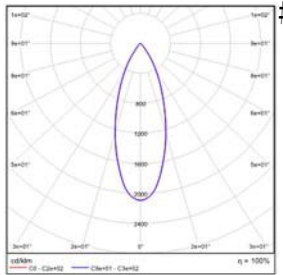

MODEL	CER22F-08EL330BWT
BEAM ANGLE	36 _°
POWER	10W
LUMENS	462LM
CBCP	1594CD
EFFICACY	46LM/W

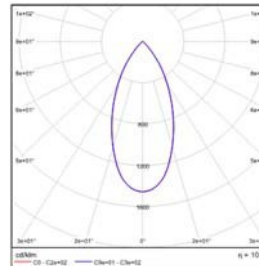

MODEL	CER22F-08EL430BWT
BEAM ANGLE	48 _°
POWER	10W
LUMENS	419LM
CBCP	775CD
EFFICACY	42LM/W

LANNE PRO - MODEL: AER23

WAC ARCHITECTURAL

Recessed Ceiling Luminaires

PROJECT :

TYPE :

Product Image



Line Drawing

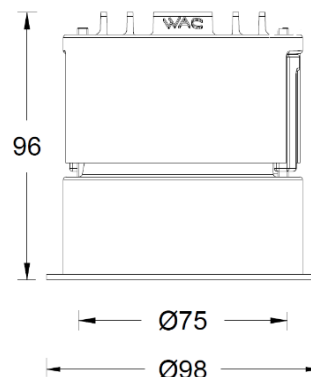

Product Description

The LANNE PRO lower lighting tube lamp is exquisite and simple, with precise light distribution. It adopts SUBROSA hidden light technology and has the ultimate anti glare effect. Mainly suitable for hotels and commercial public spaces.

Product Features

- Body Material: Aluminum alloy die-casting
- Optical System: Lens +Subrosa hidden light system
- Finish: Electrostatic powder coating,
- Adjustable Angle: /
- Accessories: /
- Certification: CCC
- IP Rating: IP65
- Insulation Level: Class I
- Operating Temperature: -20°C~50°C

Product Specifications

- Opening: Ø93mm
- Ceiling: 1mm~40mm
- Light: 35°
- Light source type: COB
- Source Lm: 1800lm
- LED Lifetime: >50000h-L70/B10-Ta25°C(LM-80/TM-21)
- CCT/CRI: 2700K/ 3000K/ 4000K , Ra90
- SDCM: 3 SDCM
- Input: 220V~240V AC / 50Hz
- Dimming: No dimming/0-10V dimming
- Net Weight: 1.5Kg without packing

Order Model

Model	Size	Comment	LED Power	Driver	Beam	CCT	Reflector	Finish
AER2	3 3"	F Frame	13 13W	EL ON-OFF 220V AC Power Supply	1 15°	27 2700K	B Black	WT White
					2 28°			
					3 38°			
					4 45°			
					5 58°			
AER2	3 3"	F Frame	18 18W	DL 0-10V Dimming 220V AC Power Supply	3 38°	30 3000K	S Specular	WT White
					4 45°			
					5 58°			
					30 3000K			
					40 4000K			

Example : AER23F-13EL130BWT

Recessed Ceiling Luminaires

PROJECT :

TYPE :

LIGHT DISTRIBUTION@3000K LUMINAIRE DATA

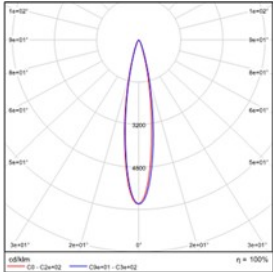

MODEL : AER23F-13EL130BWT
BEAM ANGLE : 15°
POWER : 14W
LUMENS : 844LM
CBCP : 5213CD
EFFICACY : 60 LM/W

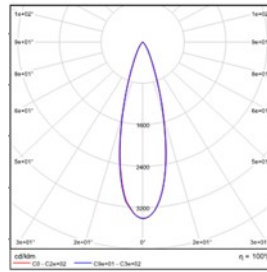

MODEL : AER23F-13EL230BWT
BEAM ANGLE : 24°
POWER : 14W
LUMENS : 791LM
CBCP : 2860CD
EFFICACY : 56.6LM/W

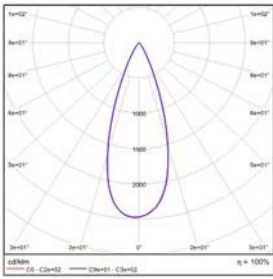

MODEL : AER23F-13EL330BWT
BEAM ANGLE : 38°
POWER : 14W
LUMENS : 904LM
CBCP : 2477CD
EFFICACY : 65LM/W

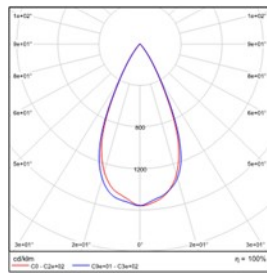

MODEL : AER22F-08EL430BWT
BEAM ANGLE : 45°
POWER : 14W
LUMENS : 882LM
CBCP : 1504CD
EFFICACY : 62LM/W

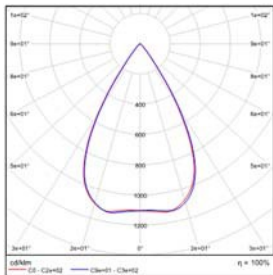

MODEL : AER23F-13EL530BWT
BEAM ANGLE : 58°
POWER : 14W
LUMENS : 925LM
CBCP : 1111CD
EFFICACY : 67LM/W

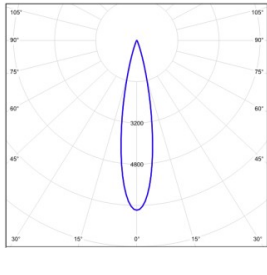

MODEL : AER23F-18EL130BWT
BEAM ANGLE : 15°
POWER : 21W
LUMENS : 1047LM
CBCP : 6468CD
EFFICACY : 50LM/W

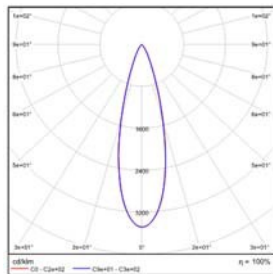

MODEL : AER23F-18EL230BWT
BEAM ANGLE : 28°
POWER : 21W
LUMENS : 1084LM
CBCP : 3518CD
EFFICACY : 52LM/W

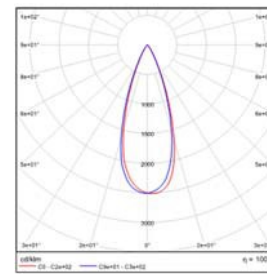

MODEL : AER23F-18EL330BWT
BEAM ANGLE : 38°
POWER : 21W
LUMENS : 1241LM
CBCP : 3028CD
EFFICACY : 59LM/W

LANNE PRO - MODEL: AER23

WAC ARCHITECTURAL

Recessed Ceiling Luminaires

PROJECT :

TYPE :

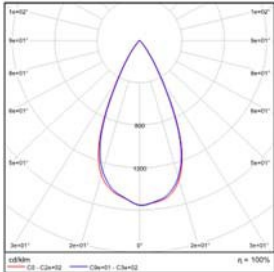

MODEL : AER23F-18EL430BWT

BEAM ANGLE : 45°

POWER : 21W

LUMENS : 1096LM

CBCP : 1861CD

EFFICACY : 52LM/W

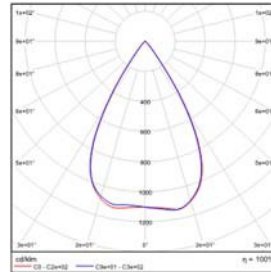

MODEL : AER23F-18EL530BWT

BEAM ANGLE : 58°

POWER : 21W

LUMENS : 1204LM

CBCP : 1419CD

EFFICACY : 57LM/W

Recessed Ceiling Luminaires

PROJECT :

TYPE :

Product Image



Line Drawing

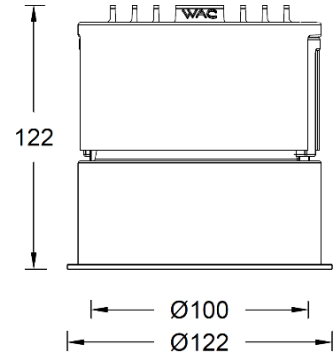

Product Description

The LANNE PRO lower lighting tube lamp is exquisite and simple, with precise light distribution. It adopts SUBROSA hidden light technology and has the ultimate anti glare effect. Mainly suitable for hotels and commercial public spaces.

Product Features

- Body Material: Aluminum alloy die-casting
- Optical System: Lens +Subrosa hidden light system
- Finish: Electrostatic powder coating,
- Adjustable Angle: /
- Accessories: /
- Certification: CCC
- IP Rating: IP65
- Insulation Level: Class I
- Operating Temperature: -20°C~50°C

Product Specifications

- Opening: Ø116mm
- Ceiling: 1mm~40mm
- Light: 35°
- Light source type: COB
- Source Lm: 2500lm
- LED Lifetime: >50000h-L70/B10-Ta25°C(LM-80/TM-21)
- CCT/CRI: 2700K/ 3000K/ 4000K , Ra90
- SDCM: 3 SDCM
- Input: 220V~240V AC / 50Hz
- Dimming: No dimming/0-10V dimming
- Net Weight: 1.5Kg without packing

Order Model

Model	Size	Comment	LED Power	Driver	Beam	CCT	Reflector	Finish
AER2	4 4"	F Frame	18 18W 25 25W	EL ON-OFF	1 20°	27 2700K 30 3000K 40 4000K	B Black S Specular	WT White
				220V AC Power Supply	2 30°			
				DL 0-10V Dimming	3 40°			
				220V AC Power Supply	4 50°			
					5 60°			

Example : AER24F-18EL130BWT

Recessed Ceiling Luminaires

PROJECT :

TYPE :

LIGHT DISTRIBUTION@3000K LUMINAIRE DATA

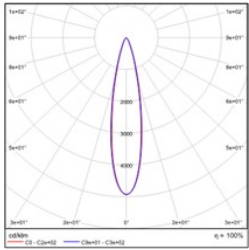

MODEL : AER24F-18EL230BWT
BEAM ANGLE : 20°
POWER : 21W
LUMENS : 1445LM
CBCP : 7312CD
EFFICACY : 69 LM/W

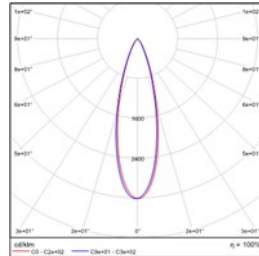

MODEL : AER24F-18EL330BWT
BEAM ANGLE : 30°
POWER : 21W
LUMENS : 1332LM
CBCP : 4308CD
EFFICACY : 64LM/W

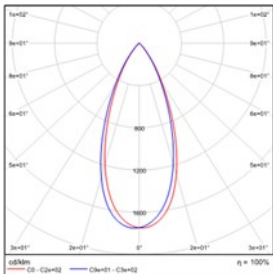

MODEL : AER24F-18EL430BWT
BEAM ANGLE : 40°
POWER : 21W
LUMENS : 1371LM
CBCP : 2315CD
EFFICACY : 66LM/W

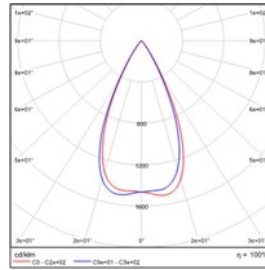

MODEL : AER24F-18EL530BWT
BEAM ANGLE : 50°
POWER : 21W
LUMENS : 1660LM
CBCP : 2312CD
EFFICACY : 80LM/W

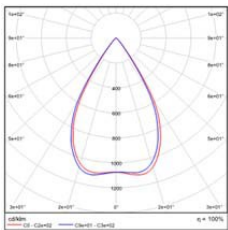

MODEL : AER24F-18EL630BWT
BEAM ANGLE : 60°
POWER : 21W
LUMENS : 1584LM
CBCP : 1678CD
EFFICACY : 76LM/W

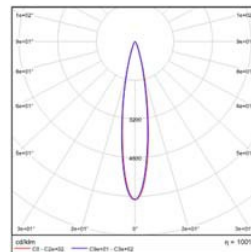

MODEL : AER24F-25EL230BWT
BEAM ANGLE : 20°
POWER : 30W
LUMENS : 1446LM
CBCP : 10066CD
EFFICACY : 66LM/W

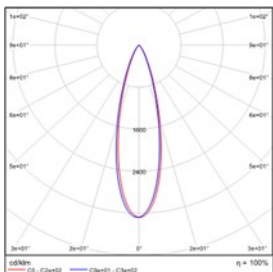

MODEL : AER24F-25EL330BWT
BEAM ANGLE : 30°
POWER : 30W
LUMENS : 1771LM
CBCP : 5953CD
EFFICACY : 60LM/W

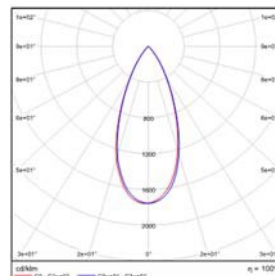

MODEL : AER24F-25EL430BWT
BEAM ANGLE : 40°
POWER : 30W
LUMENS : 1817LM
CBCP : 3164CD
EFFICACY : 61.5LM/W

Recessed Ceiling Luminaires

PROJECT :

TYPE :

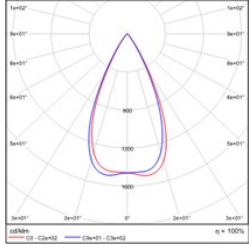

MODEL : AER24F-25EL530BWT
BEAM ANGLE : 50°
POWER : 30W
LUMENS : 2183LM
CBCP : 3281CD
EFFICACY : 74LM/W

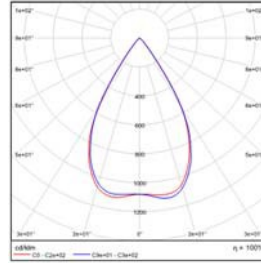

MODEL : AER24F-25EL630BWT
BEAM ANGLE : 60°
POWER : 30W
LUMENS : 2109LM
CBCP : 2337CD
EFFICACY : 71.2LM/W

Recessed Ceiling Luminaires

PROJECT :

TYPE :

Product Image



Line Drawing

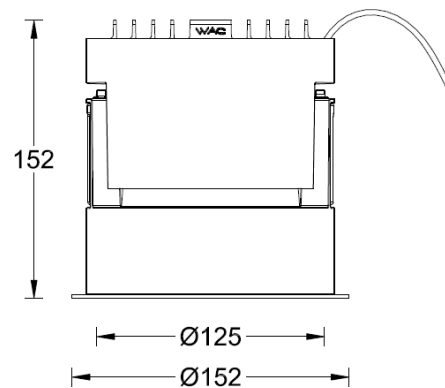

Product Description

The LANNE PRO lower lighting tube lamp is exquisite and simple, with precise light distribution. It adopts SUBROSA hidden light technology and has the ultimate anti glare effect. Mainly suitable for hotels and commercial public spaces.

Product Features

- Body Material: Aluminum alloy die-casting
- Optical System: Lens +Subrosa hidden light system
- Finish: Electrostatic powder coating,
- Adjustable Angle: /
- Accessories: /
- Certification: CCC
- IP Rating: IP65
- Insulation Level: Class I
- Operating Temperature: -20°C~50°C

Product Specifications

- Opening: Ø145mm
- Ceiling: 1mm~40mm
- Light: 35°
- Light source type: COB
- Source Lm: 4500lm
- LED Lifetime: >50000h-L70/B10-Ta25°C(LM-80/TM-21)
- CCT/CRI: 2700K/ 3000K/ 4000K , Ra90
- SDCM: 3 SDCM
- Input: 220V~240V AC / 50Hz
- Dimming: No dimming/0-10V dimming
- Net Weight: 2.3Kg without packing

Order Model

Model	Size	Comment	LED Power	Driver	Beam	CCT	Reflector	Finish
AER2	5 5"	F Frame	32 32W 40 40W	EL ON-OFF	1 15° 2 24° 3 36°	27 2700K	B Black S Specular	WT White
				220V AC Power Supply		30 3000K		
				DL 0-10V Dimming		40 4000K		
				220V AC Power Supply				

Example: AER25F-32EL130BWT

Recessed Ceiling Luminaires

PROJECT :

TYPE :

LIGHT DISTRIBUTION@3000K LUMINAIRE DATA

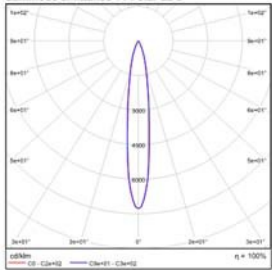

MODEL : AER25F-32EL130BWT
BEAM ANGLE : 15°
POWER : 35W
LUMENS : 3010LM
CBCP : 21693CD
EFFICACY : 86 LM/W

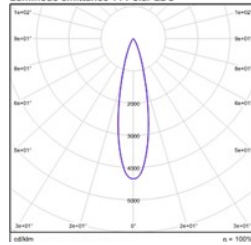

MODEL : AER25F-32EL230BWT
BEAM ANGLE : 24°
POWER : 35W
LUMENS : 2870LM
CBCP : 12243CD
EFFICACY : 82LM/W

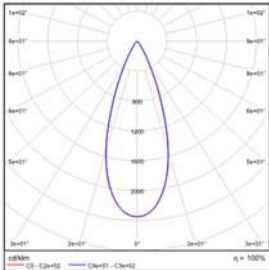

MODEL : AER25F-32EL330BWT
BEAM ANGLE : 36°
POWER : 35W
LUMENS : 29051LM
CBCP : 6624CD
EFFICACY : 83LM/W

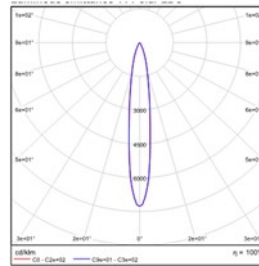

MODEL : AER25F-32EL130BWT
BEAM ANGLE : 15°
POWER : 43W
LUMENS : 3683LM
CBCP : 2650CD
EFFICACY : 86LM/W

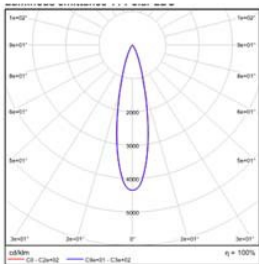

MODEL : AER25F-40EL230BWT
BEAM ANGLE : 24°
POWER : 43W
LUMENS : 3537LM
CBCP : 15030CD
EFFICACY : 82.3LM/W

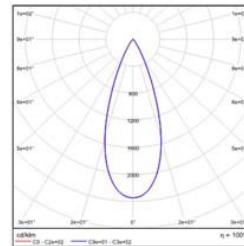

MODEL : AER25F-40EL330BWT
BEAM ANGLE : 36°
POWER : 43W
LUMENS : 3605LM
CBCP : 8163CD
EFFICACY : 83.7LM/W