

Swallow III High Power COB

WTK-42 | WHK-42 | MO-N42 | MO-R42

Fixture Type: _____
 Project: _____
 Catalog#: _____
 Location: _____



LINE DRAWING

Track Mounted (WTK, WHK)

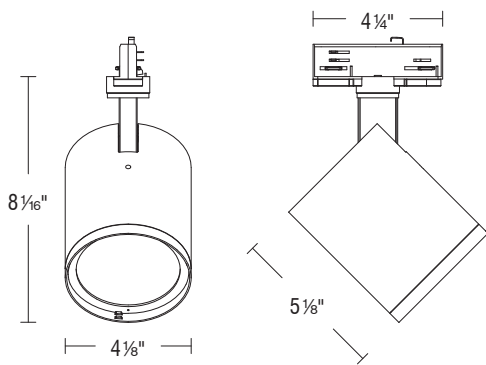

New Construction (MO-N42)

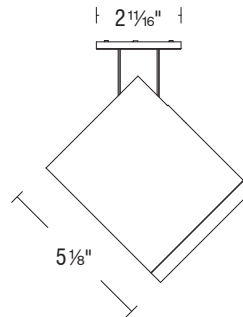
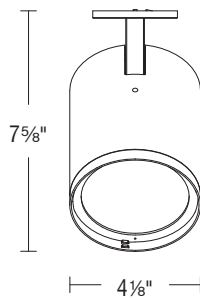

Remodel (MO-R42)

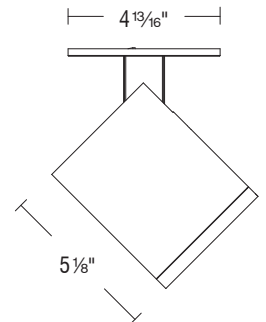
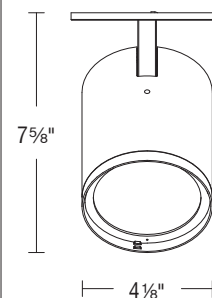

PRODUCT DESCRIPTION

Designed for W two-circuit track systems, the Swallow III features a sleek, refined appearance with a die-cast aluminum housing and a concealed heat sink for a clean, modern look. It utilizes a high-performance COB LED module, offering multiple standard CCT options and excellent color rendering. A variety of beam angles are available, and interchangeable accessories can be easily replaced by hand to create different lighting effects.

SPECIFICATIONS

Construction:	Die-cast aluminum alloy body
Mounting:	Track mounted
Light Source:	High output 3-step Mac Adam Ellipse Rated life of 50,000 hours at L70
Input:	Universal 120-277V AC, 50/60 Hz
Dimming:	ELV, TRIAC, and 0-10V: 100 - 1%
Operating Temperature:	-4°F to 104°F (-20°C to 40°C)
Standards:	ETL & cETL
Warranty:	5 year WAC Lighting guaranteed warranty

BEAM ANGLES



FINISHES



Swallow III High Power COB

WTK-42 | WHK-42 | MO-N42 | MO-R42

Fixture Type: _____
 Project: _____
 Catalog#: _____
 Location: _____

ORDERING INFORMATION

CONFIGURATION TABLE			
Model & Power	Beam Angle	Color Temperature & CRI	Housing Finish
WTK-42 (120V)	V - Very Narrow 8°	927 - 2700K - 90	BK - BLACK
WHK-42 (277V)	S - Spot 15°	930 - 3000K - 90	WT - WHITE
MO-N42 (120-277V)	N - Narrow Flood 24°	935 - 3500K - 90	
MO-R42 (120-277V)	M - Medium Flood 36°	940 - 4000K - 90	
	W - Wide Flood 55°		

W_K-42S-_____

Example: WTK-42S-S930WT

MO-_42S-_____

Example: MO-N42S-M930BK

ACCESSORIES	
LENS-42H-VWT	TL42H 0D LENS MODULE WT
LENS-42H-VBK	TL42H 0D LENS MODULE B
LENS-42H-SWT	TL42H 15D DIFFUSION LENS MODULE WT
LENS-42H-SBK	TL42H 15D DIFFUSION LENS MODULE BK
LENS-42H-NWT	TL42H 24D DIFFUSION LENS MODULE WT
LENS-42H-NBK	TL42H 24D DIFFUSION LENS MODULE BK
LENS-42H-MWT	TL42H 36D DIFFUSION LENS MODULE WT
LENS-42H-MBK	TL42H 36D DIFFUSION LENS MODULE BK
LENS-42H-WWT	TL42H 55D DIFFUSION LENS MODULE WT
LENS-42H-WBK	TL42H 55D DIFFUSION LENS MODULE BK
LENS-42H-HWT	TL42H INTEGRAL HONEYCOMB MODULE WT
LENS-42H-HBK	TL42H INTEGRAL HONEYCOMB MODULE WT
LENS-42H-AWT	TL42H WALL WASHING LENS MODULE WT
LENS-42H-ABK	TL42H WALL WASHING LENS MODULE BK
LENS-42H-EWT	TL42H ELLIPSE LENS MODULE 15X55D WT
LENS-42H-EBK	TL42H ELLIPSE LENS MODULE 15X55D BK
LENS-42H-GWT	TL42H ELLIPSE LENS MODULE 22X55D WT
LENS-42H-GBK	TL42H ELLIPSE LENS MODULE 22X55D BK
LENS-42H-SNT-WT	TL42H INTEGRAL CONDENSER MODULE WT
LENS-42H-SNT-BK	TL42H INTEGRAL CONDENSER MODULE BK
LENS-42H-BD-WT	TL42H FOUR LEAF SHADE MODULE WT
LENS-42H-BD-BK	TL42H FOUR LEAF SHADE MODULE BK

Swallow III High Power COB

WTK-42 | WHK-42 | MO-N42 | MO-R42

Fixture Type: _____
 Project: _____
 Catalog#: _____
 Location: _____

PERFORMANCE DATA

Polar Candela Distribution Charts

Samples shown with a 120V fixture with a Black finish set to 3000K.

Very Narrow Beam: 8° Beam

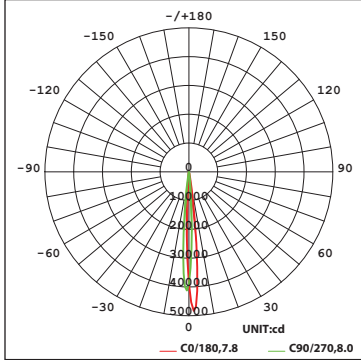

Medium Flood Beam: 36° Beam

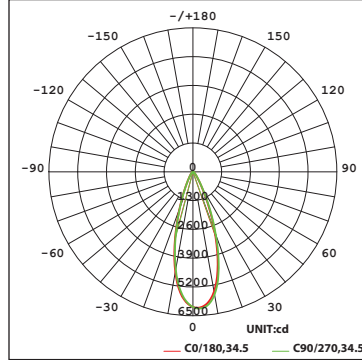

Spot Beam: 15° Beam

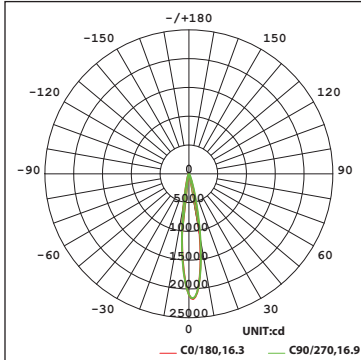

Wide Flood Beam: 55° Beam

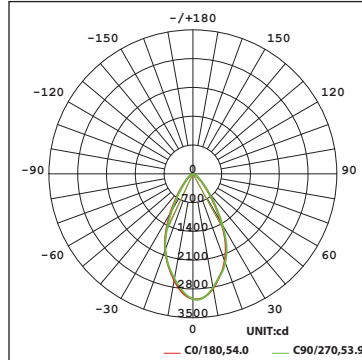

Narrow Flood Beam: 24° Beam

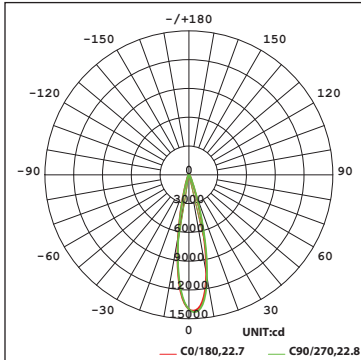

Swallow III High Power COB

WTK-42 | WHK-42 | MO-N42 | MO-R42

Fixture Type: _____
Project: _____
Catalog#: _____
Location: _____

PERFORMANCE DATA

Unified Glare Rating (UGR) Table

UGR values shown are calculated for a fixture with a Very Narrow Beam (8°) optic at 3000K and 90 CRI. General performance of other beam angles shown below.

ceiling/cavity	0.7	0.7	0.5	0.5	0.3	0.7	0.7	0.5	0.5	0.3	
walls	0.5	0.3	0.5	0.3	0.3	0.5	0.3	0.5	0.3	0.3	
working plane	0.2	0.2	0.2	0.2	0.2	0.2	0.2	0.2	0.2	0.2	
Room dimensions	Viewed crosswise					Viewed endwise					
x = 2H y = 2H	8.7	9.3	8.9	9.4	9.5	9.6	10.1	9.8	10.3	10.4	
3H	8.6	9.1	8.9	9.3	9.5	9.6	10.1	9.8	10.2	10.4	
4H	8.6	9.0	8.8	9.2	9.5	9.5	10.0	9.8	10.2	10.4	
6H	8.5	8.9	8.8	9.2	9.4	9.4	9.9	9.7	10.1	10.3	
8H	8.5	8.9	8.7	9.1	9.4	9.4	9.8	9.7	10.1	10.3	
12H	8.4	8.8	8.7	9.1	9.3	9.3	9.8	9.6	10.0	10.3	
4H	2H	8.7	9.2	8.9	9.4	9.6	9.5	10.0	9.8	10.2	10.4
3H	8.6	9.0	8.9	9.2	9.5	9.5	9.9	9.8	10.1	10.4	
4H	8.5	8.9	8.8	9.2	9.5	9.4	9.8	9.7	10.1	10.4	
6H	8.4	8.7	8.7	9.1	9.4	9.3	9.6	9.6	10.0	10.3	
8H	8.3	8.6	8.7	9.0	9.4	9.2	9.5	9.6	9.9	10.3	
12H	8.3	8.6	8.7	8.9	9.3	9.2	9.5	9.6	9.8	10.2	
8H	4H	8.3	8.7	8.7	9.0	9.4	9.2	9.5	9.6	9.9	10.3
6H	8.2	8.5	8.6	8.9	9.3	9.1	9.4	9.5	9.8	10.2	
8H	8.1	8.4	8.6	8.8	9.2	9.0	9.3	9.5	9.7	10.1	
12H	8.1	8.3	8.5	8.7	9.2	9.0	9.2	9.4	9.6	10.1	
12H	4H	8.3	8.6	8.7	8.9	9.3	9.2	9.5	9.6	9.8	10.2
6H	8.1	8.4	8.6	8.8	9.2	9.0	9.3	9.5	9.7	10.1	
8H	8.1	8.3	8.5	8.7	9.2	9.0	9.2	9.4	9.6	10.1	

Round Fixture	Angle	UGR Range
Very Narrow	8°	≤10
Spot	15°	≤16
Narrow Flood	24°	≤15
Medium Flood	36°	≤18
Wide Flood	55°	≤23

Lumens and CBCP Multiplier Table

Use the below table to determine lumens and CBCP values for the combinations of power, color temperature, and CRI values.

Color Temperature			
2700K	3000K	3500K	4000K
0.93	1.00	1.07	1.14

wacarchitectural.com | WAC Architectural, a WAC Group brand.

WAC Group Headquarters
44 Harbor Park Drive
Port Washington, NY 11050

WAC Lighting
Phone (800) 526.2588
Fax (800) 526.2585

APR 2026 | P. 4 of 4

WAC GROUP