

## Panther Static White PAL8 (65W)

Fixture Type: \_\_\_\_\_  
 Project: \_\_\_\_\_  
 Catalog#: \_\_\_\_\_  
 Location: \_\_\_\_\_

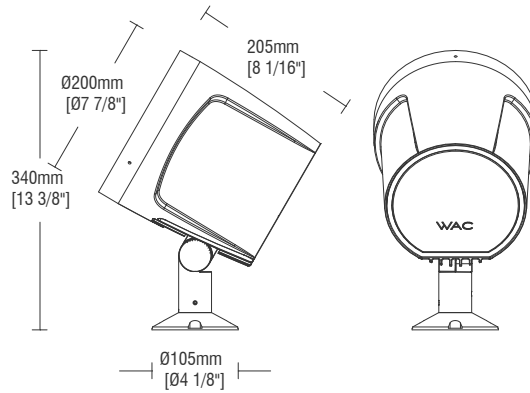

### PRODUCT DESCRIPTION

Utilizing the latest LED technology, the PANTHER series of luminaire features a low-profile design and high optical performance, available in a variety of sizes. The series supports vertical or horizontal mounting with precise adjustments in the direction of rotation. Recommended for architectural façade lighting or landscape spotlighting.

### SPECIFICATIONS

<b>Construction:</b>	Durable die-cast aluminum construction
<b>Mounting:</b>	Outdoor installation
<b>Light Source:</b>	High output 3-step Mac Adam Ellipse Rated life of 50,000 hours at L70
<b>Input:</b>	Universal 120-277V AC, 50/60 Hz
<b>Power:</b>	65W
<b>Dimming:</b>	0-10V, DMX512-A with RDM
<b>Maximum Delivered Intensity:</b>	Up to 462,782 cd (Ultra Narrow 6°, 4000K)
<b>Maximum Delivered Output:</b>	Up to 4,301 lm (Ultra Narrow 6°, 4000K)
<b>Operating Temperature:</b>	-4°F to 122°F (-20°C to 50°C)
<b>Standards:</b>	ETL & cETL Wet location listed
<b>Warranty:</b>	5 year WAC Lighting guaranteed warranty

### BEAM ANGLES



### FINISHES



Model	Beam	Lumens Ref Output*	CBCP	Efficacy (lm/W)	Color Temp
PAL8 Ø200mm Ø7.9"	U 4°	4,020	432,507	57	927-2700K
	V 7°	3,955	176,617	58	
	S 10°	3,859	69,891	58	
	N 22°	3,080	14,020	57	935-3500K
	M 33°	3,409	8,398	46	
	F 47°	2,755	3,977	50	
	E 14° x 44°	2,751	12,697	41	

\*Lumens and CBCP are reference values for 3000K Color Temperature. Refer to Multiplier Table in Performance Data to determine other outputs.

## Panther Static White PAL8 (65W)

Fixture Type: \_\_\_\_\_  
 Project: \_\_\_\_\_  
 Catalog#: \_\_\_\_\_  
 Location: \_\_\_\_\_

### ORDERING INFORMATION

CONFIGURATION TABLE				
Model & Power	Dimming	Beam Angle	Color Temperature & CRI	Housing Finish
<b>PAL8 (65W)</b>	<b>L - 0-10V</b> <b>D - DMX512-A</b>	<b>U - Ultra Narrow 4°</b>	<b>927 - 2700K - 90</b>	<b>BK - BLACK</b>
		<b>V - Very Narrow 7°</b>	<b>930 - 3000K - 90</b>	
		<b>S - Spot 10°</b>	<b>940 - 4000K - 90</b>	
		<b>N - Narrow Flood 22°</b>		
		<b>M - Medium Flood 33°</b>		
		<b>F - Flood 47°</b>		
		<b>E - Elongating 14° x 47°</b>		

### PAL8-65\_ - \_\_\_\_-BK

Example: PAL8-65D-M930-BK

ACCESSORIES	
PAL8-SHR-BK	<i>Panther 8" Shroud - Black</i>
PAL8-SNOOT-BK	<i>Panther 8" Snoot - Black</i>
AL-TMS-BK	<i>Tree Mount Bracket - Small</i>
AL-TML-BK	<i>Tree Mount Bracket - Large</i>
AL-TRM-BK	<i>Tree Ring Mount</i>
M6000-STAKE	<i>Ground Stake</i>
AL-PM-BK	<i>Pole Mount Bracket</i>
AL-PS-3-BK	<i>3" Pole Sleeve</i>
AL-PCM-S-BK	<i>Pole Clamp - Single</i>
AL-PCM-AD-BK	<i>Pole Clamp Adjustable - Double</i>

Fixture Type: \_\_\_\_\_  
 Project: \_\_\_\_\_  
 Catalog#: \_\_\_\_\_  
 Location: \_\_\_\_\_

### PERFORMANCE DATA

#### Polar Candela Distribution Charts

Samples shown from a fixture set to 3000K.

**U - Ultra Narrow 4°**

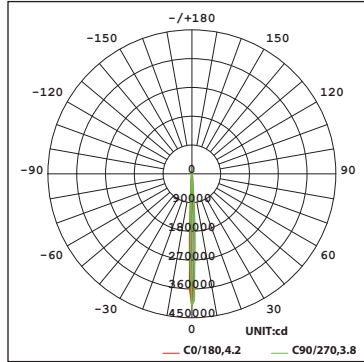

**N - Narrow Flood Beam 22°**

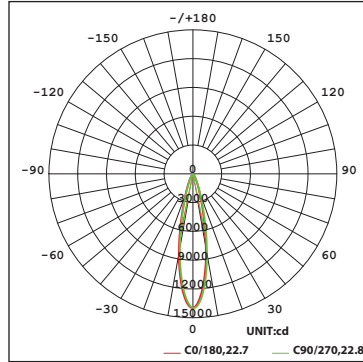

**E - Elongating 14° x 44°**

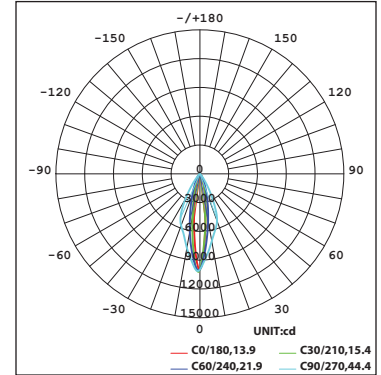

**V - Very Narrow 7°**

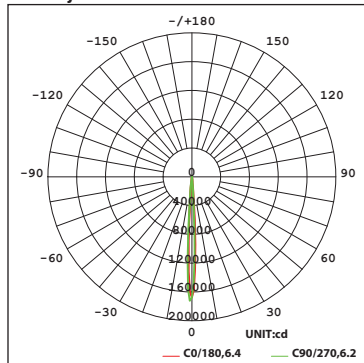

**M - Medium Flood Beam 33°**

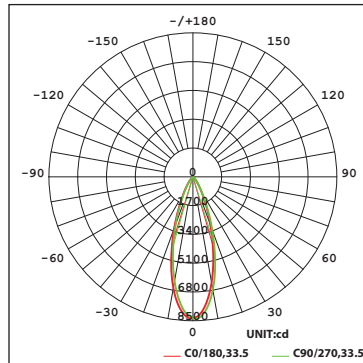

**S - Spot Beam 10°**

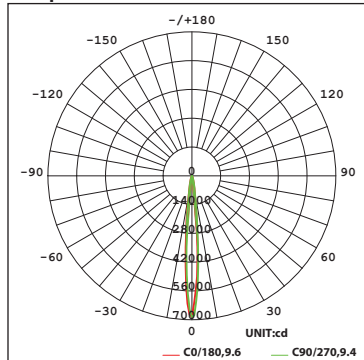

**F - Flood Beam 47°**

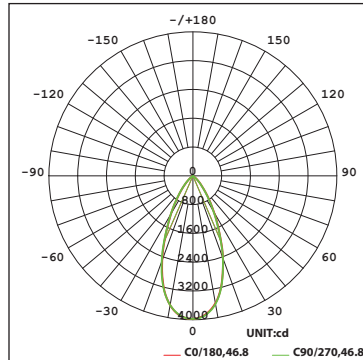

## Panther Static White PAL8 (65W)

Fixture Type: \_\_\_\_\_  
 Project: \_\_\_\_\_  
 Catalog#: \_\_\_\_\_  
 Location: \_\_\_\_\_

### PERFORMANCE DATA

#### Unified Glare Rating (UGR) Table

Samples shown from a fixture with an Ultra Narrow 4° beam set to 3000K. General performance of other beam angles shown below.

ceiling/cavity	0.7	0.7	0.5	0.5	0.3	0.7	0.7	0.5	0.5	0.3	
walls	0.5	0.3	0.5	0.3	0.3	0.5	0.3	0.5	0.3	0.3	
working plane	0.2	0.2	0.2	0.2	0.2	0.2	0.2	0.2	0.2	0.2	
Room dimensions	Viewed crosswise					Viewed endwise					
x = 2H y = 2H	5.5	6.0	5.7	6.1	6.3	5.3	5.8	5.5	5.9	6.1	
3H	5.6	6.1	5.9	6.3	6.4	5.4	5.8	5.6	6.0	6.2	
4H	5.6	6.0	5.8	6.2	6.4	5.3	5.8	5.6	6.0	6.2	
6H	5.5	5.9	5.8	6.1	6.4	5.3	5.7	5.5	5.9	6.1	
8H	5.5	5.9	5.8	6.1	6.3	5.2	5.6	5.5	5.8	6.1	
12H	5.4	5.8	5.7	6.1	6.3	5.2	5.6	5.5	5.8	6.1	
4H	2H	5.6	6.0	5.8	6.2	6.4	5.4	5.8	5.7	6.0	6.2
3H	5.7	6.1	6.0	6.4	6.6	5.5	5.9	5.8	6.1	6.4	
4H	5.7	6.0	6.0	6.3	6.6	5.4	5.8	5.7	6.0	6.3	
6H	5.6	5.9	5.9	6.2	6.5	5.3	5.6	5.7	6.0	6.3	
8H	5.5	5.8	5.9	6.1	6.5	5.3	5.6	5.6	5.9	6.3	
12H	5.4	5.7	5.8	6.1	6.5	5.2	5.5	5.6	5.8	6.2	
8H	4H	5.5	5.8	5.9	6.2	6.5	5.3	5.6	5.6	5.9	6.3
6H	5.4	5.7	5.8	6.0	6.4	5.2	5.4	5.6	5.8	6.2	
8H	5.3	5.6	5.8	6.0	6.4	5.1	5.3	5.5	5.7	6.2	
12H	5.3	5.5	5.7	5.9	6.4	5.0	5.2	5.5	5.7	6.1	
12H	4H	5.4	5.7	5.8	6.1	6.5	5.2	5.5	5.6	5.8	6.2
6H	5.3	5.6	5.8	6.0	6.4	5.1	5.3	5.5	5.7	6.2	
8H	5.3	5.5	5.7	5.9	6.4	5.0	5.2	5.5	5.7	6.1	

Fixture	Angle	UGR Range
Ultra Narrow	4°	≤7
Very Narrow	7°	≤6
Spot	10°	≤5
Narrow Flood	22°	≤11
Medium Flood	33°	≤14
Flood	47°	≤17
Elongating	14° x 44°	≤18

## Panther Static White PAL8 (65W)

Fixture Type: \_\_\_\_\_  
Project: \_\_\_\_\_  
Catalog#: \_\_\_\_\_  
Location: \_\_\_\_\_

### PERFORMANCE DATA

#### Lumens and CBCP Multiplier Table

Use the below table to determine lumens and CBCP values for the combinations of power, color temperature, and CRI values.

Color Temperature				
2700K	3000K	3500K	4000K	5000K
0.96	1.00	1.04	1.07	1.12