

Zoron

Square - 4" Ceiling Mount

C4ST | C4SL

Fixture Type: _____
 Project: _____
 Catalog#: _____
 Location: _____

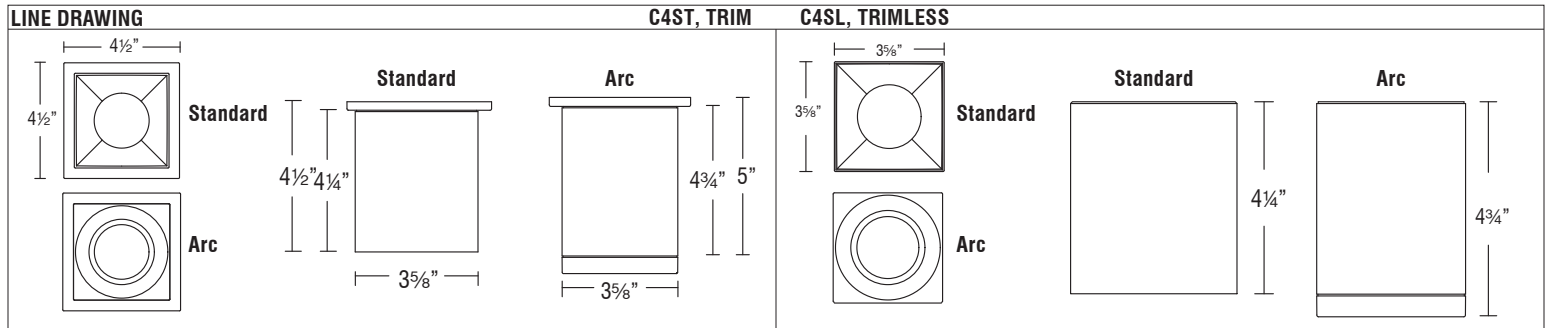
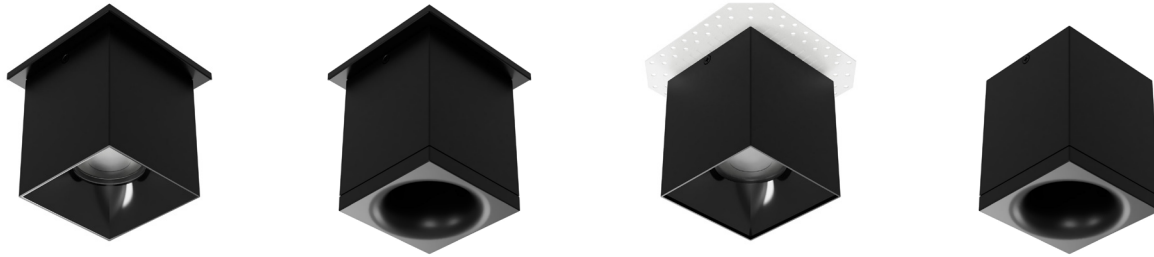

PRODUCT DESCRIPTION

The Zoron series combines sleek aesthetics with exceptional performance. Compact and stylish enough for residential applications, yet powerful enough to be used commercially. With built-in color temperature selection and the option to be used either indoors or out, Zoron adapts to any setting. Regressed trims and specialized TIR optics provide both aesthetic appeal and glare control, making Zoron the perfect blend of form and function.

SPECIFICATIONS

Construction:	Durable die-cast aluminum construction
Mounting:	Ceiling mounted
Light Source:	High output 3-step Mac Adam Ellipse COB Rated life of 50,000 hours at L70
Input:	Universal 120-277V AC 50/60 Hz
Power:	15W
Dimming:	ELV, 0-10V, TRIAC : 100 - 5%
Maximum Delivered Intensity:	Up to 3585 cd (Arc Trim, Narrow Flood 25°, 5000K)
Maximum Delivered Output:	Up to 1325 lm (Standard, Flood 45°, 5000K)
Operating Temperature:	-13°F to 122°F (-25°C to 50°C)
Standards:	IP65 rated, ETL & cETL Wet location listed Title 24 JA8 Compliant
Warranty:	5 year WAC Lighting guaranteed warranty

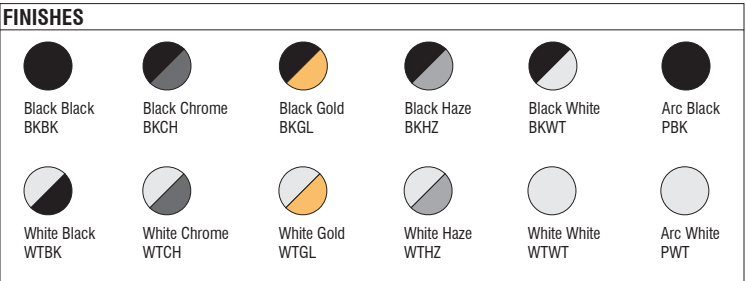

Model	Beam	Color Temp	CRI	Lumens	CBCP	Efficacy (lm/W)
C4ST Standard C4SL Trim	N 25°	2700K	90	1015	2985	68
		3000K		1060	3310	71
		3500K		1100	3235	73
		4000K		1130	3330	75
		5000K		1185	3485	79
C4ST Arc Trim C4SL Arc Trim	F 45°	2700K	90	1135	1945	76
		3000K		1180	2025	79
		3500K		1230	2105	82
		4000K		1265	2165	84
		5000K		1325	2265	88
C4ST Arc Trim C4SL Arc Trim	N 25°	2700K	90	910	3075	61
		3000K		945	3200	63
		3500K		985	3330	66
		4000K		1010	3425	67
		5000K		1060	3585	71
C4ST Arc Trim C4SL Arc Trim	F 45°	2700K	90	1065	1950	71
		3000K		1110	2035	74
		3500K		1150	2115	77
		4000K		1185	2175	79
		5000K		1240	2275	83

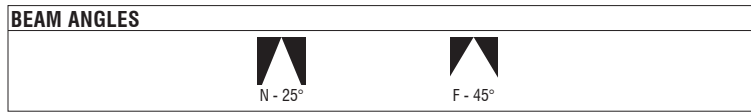

Zoron

Square - 4" Ceiling Mount

C4ST | C4SL

Fixture Type: _____

Project: _____

Catalog#: _____

Location: _____

ORDERING INFORMATION

CONFIGURATION TABLE				
Model & Power	Beam	Color Temperature & CRI	Housing Finish	Trim Finish
C4ST (TRIM)	N - 25°	CS - 5 CCT SWITCH	BK - BLACK	CH - CHROME
C4SL (TRIMLESS)	F - 45°		WT - WHITE	GL - GOLD
			PBK - ARC BLACK	HZ - HAZE
			PWT - ARC WHITE	WT - WHITE

C4S - CS - _____

Example: C4ST-NCS-WTHZ

C4ST-NCS-PBK

ORDERING NOTES

- Arc Trim fixtures can only be ordered with the finishes Arc Black (PBK) and Arc White (PWT). These finishes cannot be ordered with a trim finish.

PERFORMANCE DATA

Polar Candela Distribution Charts

Samples shown with a 15W fixture set to 3000K and 90 CRI.

Standard Trim

Narrow Flood Beam: 25° Beam

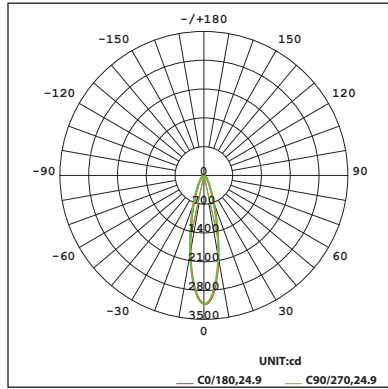

Arc Trim

Narrow Flood Beam: 25° Beam

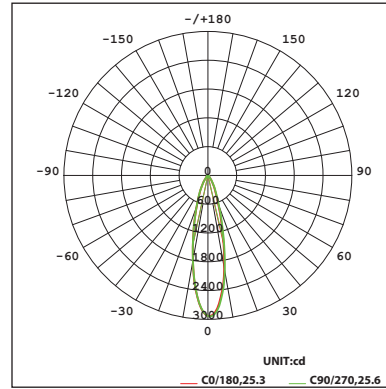

Flood Beam: 45° Beam

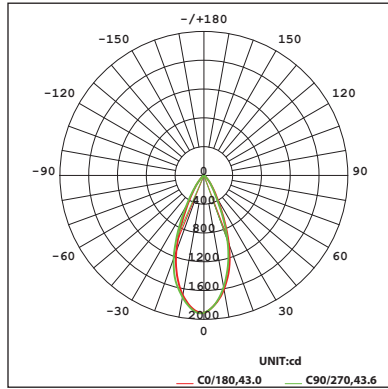

Flood Beam: 45° Beam

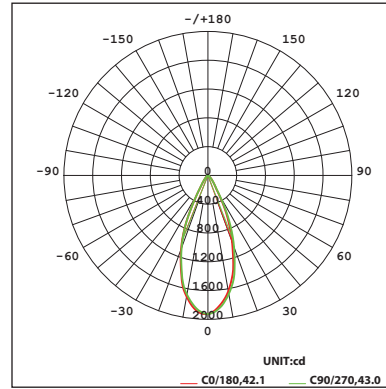

Zoron

Square - 4" Ceiling Mount

C4ST | C4SL

Fixture Type: _____

Project: _____

Catalog#: _____

Location: _____

PERFORMANCE DATA

Unified Glare Rating (UGR) Table

UGR values shown are calculated for a Standard Trim Narrow Flood Beam (25°) optic at 3000K and 90 CRI.
General performance of other beam angles shown below.

ceiling/cavity	0.7	0.7	0.5	0.5	0.3	0.7	0.7	0.5	0.5	0.3
walls	0.5	0.3	0.5	0.3	0.3	0.5	0.3	0.5	0.3	0.3
working plane	0.2	0.2	0.2	0.2	0.2	0.2	0.2	0.2	0.2	0.2
Room dimensions	Viewed crosswise					Viewed endwise				
x = 2H y = 2H	16.1	16.9	16.3	17.1	17.3	16.1	17.0	16.3	17.1	17.3
3H	16.0	16.8	16.3	17.0	17.2	16.1	16.9	16.3	17.0	17.2
4H	16.0	16.7	16.3	17.0	17.2	16.0	16.8	16.3	17.0	17.2
6H	15.9	16.6	16.2	16.9	17.1	15.9	16.7	16.2	16.9	17.1
8H	15.9	16.6	16.2	16.8	17.1	15.9	16.6	16.2	16.8	17.1
12H	15.8	16.5	16.2	16.8	17.1	15.9	16.5	16.2	16.8	17.1
4H	16.1	16.8	16.3	17.0	17.3	16.1	16.8	16.4	17.1	17.3
3H	16.0	16.7	16.4	17.0	17.2	16.1	16.7	16.4	17.0	17.3
4H	16.0	16.6	16.4	16.9	17.2	16.0	16.6	16.4	16.9	17.2
6H	16.0	16.5	16.3	16.8	17.2	16.0	16.5	16.3	16.8	17.2
8H	15.9	16.4	16.3	16.8	17.1	15.9	16.4	16.3	16.8	17.1
12H	15.9	16.3	16.3	16.7	17.1	15.9	16.4	16.3	16.7	17.1
8H	15.9	16.4	16.3	16.7	17.1	15.9	16.4	16.3	16.8	17.1
6H	15.9	16.3	16.3	16.7	17.1	15.9	16.3	16.3	16.7	17.1
8H	15.8	16.2	16.3	16.6	17.0	15.8	16.2	16.3	16.6	17.1
12H	15.8	16.1	16.3	16.6	17.0	15.8	16.1	16.3	16.6	17.0
12H	15.8	16.3	16.3	16.7	17.1	15.9	16.3	16.3	16.7	17.1
6H	15.8	16.2	16.3	16.6	17.0	15.8	16.2	16.3	16.6	17.0
8H	15.8	16.1	16.3	16.5	17.0	15.8	16.1	16.3	16.5	17.0

Beam - Standard	Angle	UGR Range
Narrow Flood	25°	≤17
Flood	45°	≤16

Beam - Arc Trim	Angle	UGR Range
Narrow Flood	25°	≤21
Flood	45°	≤20