

2" Recessed Adjustable Downlight

PROJECT:

TYPE:

Product Image



Line Drawing

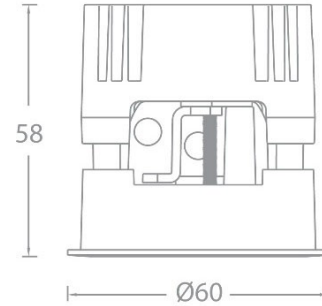

Product Description

VOLTA series LED round narrow-edge recessed angle downlights have a streamlined appearance and adopt precise lens and black mirror reflector designs to ensure that the light is emitted while still achieving the ultimate anti-glare effect. The light source cavity adopts a sealed design, which can minimize the impact of humid environment on its performance, and the reflector or optical accessories can be freely disassembled and replaced, which greatly improves on-site convenience and is mainly suitable for hotels and commercial indoor places.

Product Features

- Body Material: Aluminum alloy die-casting
- Optical System: Lens+ SUBOROSA optical system
- Finish: Static electricity powder coating
- Adjustable Angle: 0-25° tilt
- Accessories: As attached
- Certification: CCC/CE
- IP Rating: IP20(Light source cavity IP44)
- Insulation Level: Class II
- Operating Temperature: -20°C~40°C

Product Specifications

- Cut-out: Ø55
- Ceiling Thickness: 1mm~15mm
- Shielding Angle: 30°
- LED Type: HP LED
- Source Lm: 2700K 682LM; 3000K 720LM; 3500K 752LM; 4000K 765LM; 5000K 774LM;
- LED Lifetime: >50000h-L70 /B10-Ta25°C(LM-80/TM-21)
- CCT/CRI: 2700K/ 3000K/3500K/4000K/5000K, Ra90
- SDCM: 3 SDCM (4000K 5SDCM)
- Input: 220V~240V AC / 50Hz
- Dimming: On-off / 0-10V /DALI
- Net Weight: 0.2Kg without packing

Order Model

Model	Size	Trim	LED	Driver	Beam	CCT	Reflector	Finish
ADLT Downlight T series	2 2"	1 Round Trim	LD08 LED 8W	E On-Off	1 15°	27 2700K	B Black	WT White
				D 0-10V	2 24°	30 3000K	S Specular	BK Black
				A DALI	3 36°	35 3500K		
				N No Driver	5 50°	40 4000K		
					50 5000K			



Example: ADLT21-LD08E230SWT

**2" Recessed Adjustable Downlight**

PROJECT:

TYPE:

**Accessory**

<p><b>ALENS-DLT21-BEL</b> Striped glass lenses</p> 	<p><b>ALENS-DLT21-HCL</b> Edge honeycomb grille</p> 
--	---

Attention: At most one optical accessory can be added, and it is not included in the factory. It needs to be ordered separately.

**LIGHT DISTRIBUTION@3000K LUMINAIRE DATA**

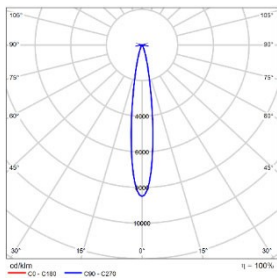

<b>MODEL :</b>	ADLT21-LD08E130SWT
<b>ANGLE :</b>	15°
<b>POWER :</b>	10W
<b>LUMENS:</b>	397lm
<b>CBCP:</b>	3074cd
<b>EFFICACY:</b>	40lm/W

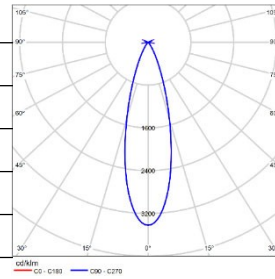

<b>MODEL:</b>	ADLT21-LD08E230SWT
<b>ANGLE:</b>	24°
<b>POWER:</b>	10W
<b>LUMENS:</b>	455lm
<b>CBCP:</b>	1795cd
<b>EFFICACY:</b>	46lm/W

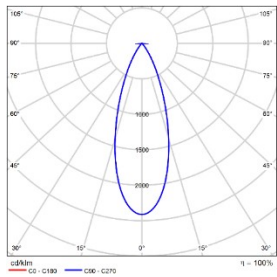

<b>MODEL :</b>	ADLT21-LD08E330SWT
<b>ANGLE:</b>	36°
<b>POWER :</b>	10W
<b>LUMENS:</b>	445lm
<b>CBCP:</b>	1005cd
<b>EFFICACY:</b>	45lm/W

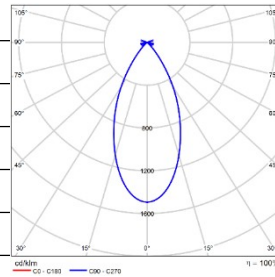

<b>MODEL:</b>	ADLT21-LD08E530SWT
<b>ANGLE:</b>	50°
<b>POWER:</b>	10W
<b>LUMENS:</b>	302lm
<b>CBCP:</b>	426cd
<b>EFFICACY:</b>	30lm/W

3" Recessed Adjustable Downlight

PROJECT:

TYPE:

Product Image



Line Drawing

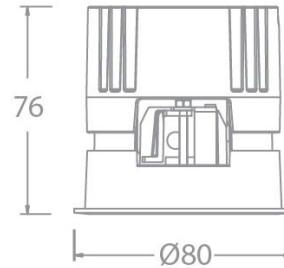

Product Description

The VOLTA series LED circular narrow edge embedded lower lighting tube lamp has a streamlined appearance and adopts precise lens and black mirror reflector design, ensuring the ultimate anti glare effect while emitting light. The light source cavity adopts a sealed design, which can minimize the impact of humid environments on its performance; Reflectors or optical accessories can also be freely disassembled and replaced, greatly improving on-site convenience, mainly suitable for hotels and commercial indoor places.

Product Features

- Body Material: Aluminum alloy die-casting
- Optical System: Lens+ SUBOROSA optical system
- Finish: Static electricity powder coating
- Adjustable Angle: /
- Accessories: As attached
- Certification: CCC
- IP Rating: IP20 (Light source cavity IP44)
- Insulation Level: Class II
- Operating Temperature: -20°C~40°C

Product Specifications

- Cut-out: Ø75mm
- Ceiling Thickness: 1mm~15mm
- Shielding Angle: 30°
- LED Type: COB
- Source Lm:
  - 2700K: 8W 682lm; 7W 758lm; 10W 1080lm; 13W 1404lm
  - 3000K: 8W 720lm; 7W 800lm; 10W 1150lm; 13W 1495lm
  - 3500K: 8W 752lm; 7W 835lm; 10W 1195lm; 13W 1554lm
  - 4000K: 8W 765lm; 7W 850lm; 10W 1210lm; 13W 1573lm
  - 5000K: 8W 774lm; 7W 860lm; 10W 1220lm; 13W 1586lm
- LED Lifetime: >50000h-L70 /B10-Ta25°C(LM-80/TM-21)
  - CCT/CRI: 2700K/3000K/3500K/4000K/5000K, CRI≥90
  - Input: 220V AC / 50Hz
  - Dimming: Non dimming/0-10V/DALI(must be matched with the project site system in advance)
- Net Weight: 0.35Kg without packing

# VOLTA-MODEL: ADLT31

WAC ARCHITECTURAL

## 3" Recessed Adjustable Downlight

PROJECT:



TYPE:

### Order model

Model	Size	Trim	LED	Driver	Beam	CCT	Reflector	Finish
ADLT Downlight T series	3 3"	1 Round Trim	<b>LD08</b> LED 8W	<b>E</b> On-Off <b>D</b> 0-10V Dimming	<b>S</b> 8° <b>1</b> 15° <b>2</b> 24° <b>3</b> 36° <b>5</b> 50°	<b>27</b> 2700K	<b>B</b> Black <b>S</b> Specular	<b>WT</b> White <b>BK</b> Black
			<b>LM07</b> COB 7W			<b>30</b> 3000K		
			<b>LM10</b> COB 10W			<b>35</b> 3500K		
			<b>LM13</b> COB 13W			<b>40</b> 4000K		
			<b>LM13</b> COB 13W			<b>50</b> 5000K		
				<b>N</b> No Driver				
				<b>A</b> DALI				

Example: ADLT31-LM13E230SWT

### Accessory

<b>ALENS-DLT31-BEL</b> Striped glass lenses 	<b>ALENS-DLT31-HCL</b> Borderless honeycomb grille 
--	---

Attention: At most one optical accessory can be added, and it is not included in the factory. It needs to be ordered separately.

**3" Recessed Adjustable Downlight**

PROJECT:

TYPE:

**LIGHT DISTRIBUTION@3000K LUMINAIRE DATA**

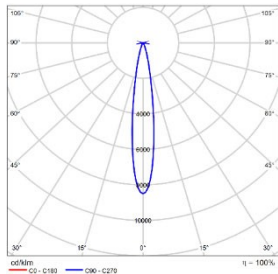
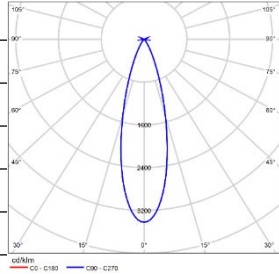
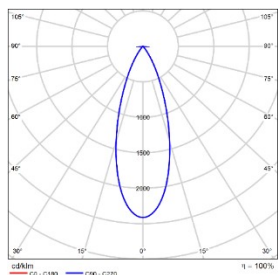
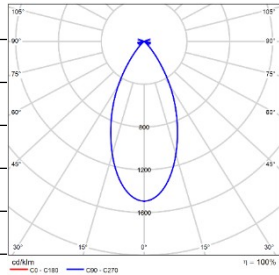
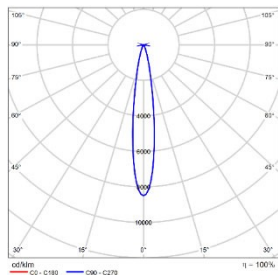
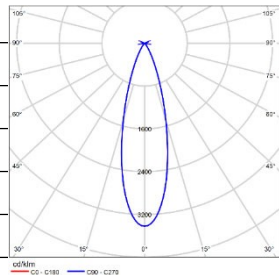
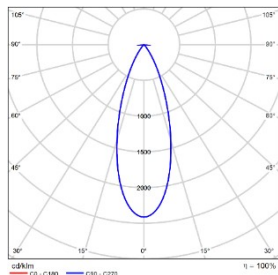
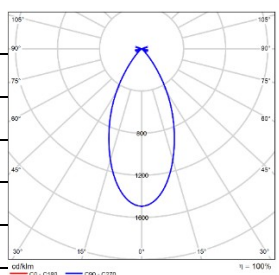
	<p><b>MODEL :</b> ADLT31-LM07E130SWT</p> <p><b>ANGLE :</b> 15°</p> <p><b>POWER :</b> 8W</p> <p><b>LUMENS:</b> 438lm</p> <p><b>CBCP:</b> 3725cd</p> <p><b>EFFICACY:</b> 55lm/W</p>		<p><b>MODEL:</b> ADLT31-LM07E230SWT</p> <p><b>ANGLE:</b> 24°</p> <p><b>POWER:</b> 8W</p> <p><b>LUMENS:</b> 554lm</p> <p><b>CBCP:</b> 1894cd</p> <p><b>EFFICACY:</b> 69lm/W</p>
	<p><b>MODEL :</b> ADLT31-LM07E330SWT</p> <p><b>ANGLE :</b> 36°</p> <p><b>POWER :</b> 8W</p> <p><b>LUMENS:</b> 456lm</p> <p><b>CBCP:</b> 1101cd</p> <p><b>EFFICACY:</b> 57lm/W</p>		<p><b>MODEL:</b> ADLT31-LM07E530SWT</p> <p><b>ANGLE :</b> 50°</p> <p><b>POWER:</b> 8W</p> <p><b>LUMENS:</b> 378lm</p> <p><b>CBCP:</b> 565cd</p> <p><b>EFFICACY:</b> 47lm/W</p>
	<p><b>MODEL :</b> ADLT31-LM10E130SWT</p> <p><b>ANGLE :</b> 15°</p> <p><b>POWER :</b> 11W</p> <p><b>LUMENS:</b> 542lm</p> <p><b>CBCP:</b> 4604cd</p> <p><b>EFFICACY:</b> 49lm/W</p>		<p><b>MODEL:</b> ADLT31-LM10E230SWT</p> <p><b>ANGLE:</b> 24°</p> <p><b>POWER:</b> 11W</p> <p><b>LUMENS:</b> 685lm</p> <p><b>CBCP:</b> 2341cd</p> <p><b>EFFICACY:</b> 62lm/W</p>
	<p><b>MODEL :</b> ADLT31-LM10E330SWT</p> <p><b>ANGLE :</b> 36°</p> <p><b>POWER:</b> 11W</p> <p><b>LUMENS:</b> 564lm</p> <p><b>CBCP:</b> 1361cd</p> <p><b>EFFICACY:</b> 51lm/W</p>		<p><b>MODEL:</b> ADLT31-LM10E530SWT</p> <p><b>ANGLE:</b> 50°</p> <p><b>POWER:</b> 11W</p> <p><b>LUMENS:</b> 467lm</p> <p><b>CBCP:</b> 698cd</p> <p><b>EFFICACY:</b> 42lm/W</p>

**3" Recessed Adjustable Downlight**

PROJECT:

TYPE:

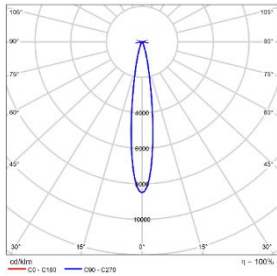

**MODEL :** ADLT31-LM13E130SWT  
**ANGLE :** 15°  
**POWER :** 15W  
**LUMENS:** 710lm  
**CBCP:** 6027cd  
**EFFICACY:** 47lm/W

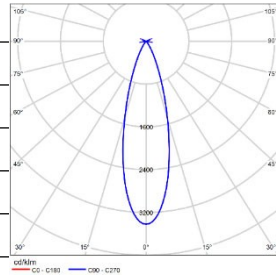

**MODEL:** ADLT31-LM13E230SWT  
**ANGLE:** 24°  
**POWER:** 15W  
**LUMENS:** 896lm  
**CBCP:** 3065cd  
**EFFICACY:** 60lm/W

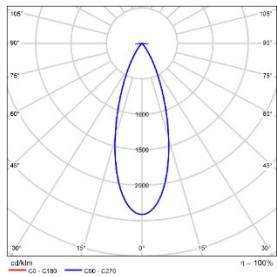

**MODEL :** ADLT31-LM13E330SWT  
**ANGLE :** 36°  
**POWER :** 15W  
**LUMENS:** 738lm  
**CBCP:** 1782cd  
**EFFICACY:** 49lm/W

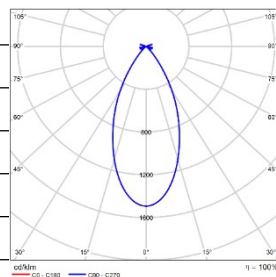

**MODEL:** ADLT31-LM13E530SWT  
**ANGLE:** 50°  
**POWER:** 15W  
**LUMENS:** 612lm  
**CBCP:** 914cd  
**EFFICACY:** 41lm/W

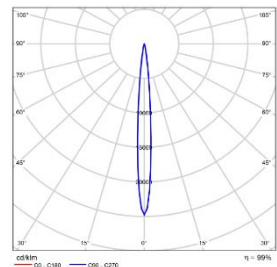

**MODEL :** ADLT31-LD08ES30SWT  
**ANGLE :** 8°  
**POWER:** 11W  
**LUMENS:** 375lm  
**CBCP:** 9280cd  
**EFFICACY:** 34lm/W