

2" Round Recessed Adjustable Downlight

PROJECT:

TYPE:

Product Image



Line Drawing

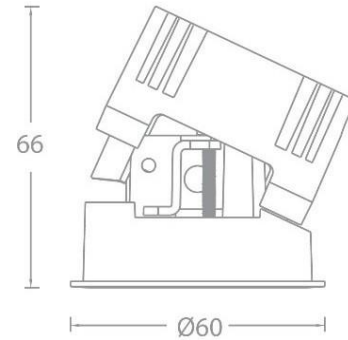

Product Description

VOLTA series LED round narrow-edge recessed angle downlights have a streamlined appearance and adopt precise lens and black mirror reflector designs to ensure that the light is emitted while still achieving the ultimate anti-glare effect. The light source cavity adopts a sealed design, which can minimize the impact of humid environment on its performance, and the reflector or optical accessories can be freely disassembled and replaced, which greatly improves on-site convenience and is mainly suitable for hotels and commercial indoor places.

Product Features

- Body Material: Aluminum alloy die-casting
- Optical System: Lens+ SUBOROSA optical system
- Finish: Static electricity powder coating
- Adjustable Angle: 0-25° tilt
- Accessories: As attached
- Certification: CCC
- IP Rating: IP20(Light source cavity IP44)
- Insulation Level: Class II
- Operating Temperature: -20°C~40°C

Product Specifications

- Cut-out: Ø55mm
- Ceiling Thickness: 1mm~15mm
- Shielding Angle: 30°
- LED Type: HP LED
- Source Lm: 2700K 682LM; 3000K 720LM; 3500K 752LM; 4000K 765LM; 5000K 774LM;
- LED Lifetime: >50000h-L70 /B10-Ta25°C(LM-80/TM-21)
- CCT/CRI: 2700K/ 3000K/3500K/4000K/5000K, Ra90
- Input: 220V AC / 50Hz
- Dimming: On-off / 0-10V /DALI
- Net Weight: 0.2Kg without packing

Order Model

Model	Size	Trim	LED	Driver	Beam	CCT	Reflector	Finish
ADDT Downlight T series	2 2"	1 Round Trim	LD08 LED 8W	E On-Off	1 15°	27 2700K	B Black	WT White
				D 0-10V	2 24°	30 3000K	S Specular	BK Black
				A DALI	3 36°	35 3500K		
				N No Driver	5 50°	40 4000K		
						50 5000K		



Example: ADDT21-LD08E230SWT

2" Round Recessed Adjustable Downlight

PROJECT:

TYPE:

Accessory

<p>ALENS-DDT21-BEL Striped glass lenses</p> 	<p>ALENS-DDT21-HCL Edge honeycomb grille</p> 
--	---

Attention: At most one optical accessory can be added, and it is not included in the factory. It needs to be ordered separately.

LIGHT DISTRIBUTION@3000K LUMINAIRE DATA

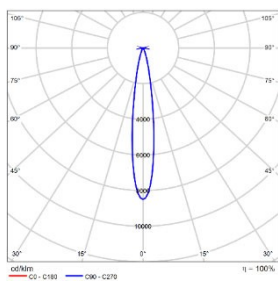
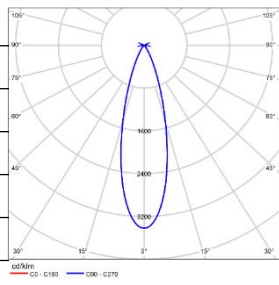
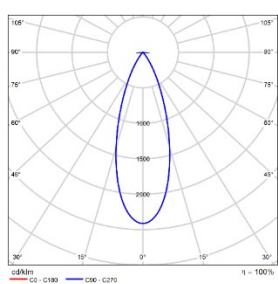
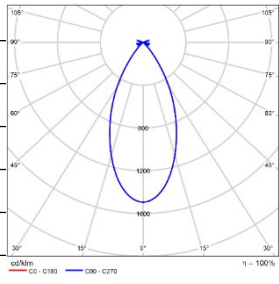
	<p>MODEL : ADDT21-LD08E130SWT ANGLE : 15° POWER : 10W LUMENS: 397lm CBCP: 3074cd EFFICACY: 40lm/W</p>		<p>MODEL: ADDT21-LD08E230SWT ANGLE: 24° POWER: 10W LUMENS: 455lm CBCP: 1795cd EFFICACY: 46lm/W</p>
	<p>MODEL : ADDT21-LD08E330SWT ANGLE: 36° POWER : 10W LUMENS: 445lm CBCP: 1005cd EFFICACY: 45lm/W</p>		<p>MODEL: ADDT21-LD08E530SWT ANGLE: 50° POWER: 10W LUMENS: 302lm CBCP: 426cd EFFICACY: 30lm/W</p>

3" Round Recessed Adjustable Downlight

PROJECT:

TYPE:

Product Image



Line Drawing

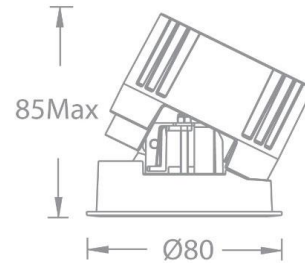

Product Description

The VOLTA series LED circular narrow edge embedded lower lighting tube lamp has a streamlined appearance and adopts precise lens and black mirror reflector design, ensuring the ultimate anti glare effect while emitting light. The light source cavity adopts a sealed design, which can minimize the impact of humid environments on its performance; Reflectors or optical accessories can also be freely disassembled and replaced, greatly improving on-site convenience, mainly suitable for hotels and commercial indoor places.

Product Features

- Body Material: Aluminum alloy die-casting
- Optical System: Lens+ SUBOROSA optical system
- Finish: Static electricity powder coating
- Adjustable Angle: 0-25° tilt
- Accessories: As attached
- Certification: CCC
- IP Rating: IP20 (Light source cavity IP44)
- Insulation Level: Class II
- Operating Temperature: -20°C~40°C

Product Specifications

- Cut-out: Ø75mm
- Ceiling Thickness: 1mm~15mm
- Shielding Angle: 30°
- LED Type: COB
- Source Lm:
 - 2700K: 8W 682lm; 7W 758lm; 10W 1080lm; 13W 1404lm
 - 3000K: 8W 720lm; 7W 800lm; 10W 1150lm; 13W 1495lm
 - 3500K: 8W 752lm; 7W 835lm; 10W 1195lm; 13W 1554lm
 - 4000K: 8W 765lm; 7W 850lm; 10W 1210lm; 13W 1573lm
 - 5000K: 8W 774lm; 7W 860lm; 10W 1220lm; 13W 1586lm
- LED Lifetime: >50000h-L70 /B10-Ta25°C(LM-80/TM-21)
 - CCT/CRI: 2700K/3000K/3500K/4000K/5000K, CRI≥90
 - Input: 220V AC / 50Hz
 - Dimming: Non dimming/0-10V/DALI(must be matched with the project site system in advance)
- Net Weight: 0.35Kg without packing

3" Round Recessed Adjustable Downlight

PROJECT:



TYPE:

Order model

Model	Size	Trim	LED	Driver	Beam	CCT	Reflector	Finish
ADDT Downlight T series	3 3"	1 Round Trim	LD08 LED 8W	E On-Off D 0-10V Dimming	S 8° 1 15° 2 24° 3 36° 5 50°	27 2700K	B Black S Specular	WT White BK Black
			LM07 COB 7W			30 3000K		
			LM10 COB 10W			35 3500K		
			LM13 COB 13W			40 4000K		
			LM13 COB 13W			50 5000K		
				N No Driver				
				A DALI				

Example: ADDT31-LM13E230SWT

Accessory

ALENS-DDT31-BEL Striped glass lenses 	ALENS-DDT31-HCL Borderless honeycomb grille 
--	---

Attention: At most one optical accessory can be added, and it is not included in the factory. It needs to be ordered separately.

3" Round Recessed Adjustable Downlight

PROJECT:

TYPE:

LIGHT DISTRIBUTION@3000K LUMINAIRE DATA

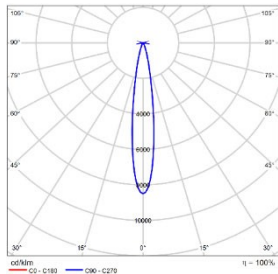
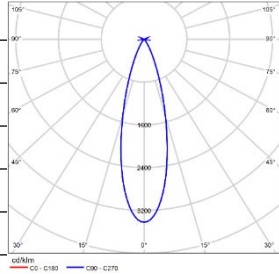
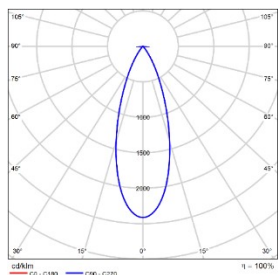
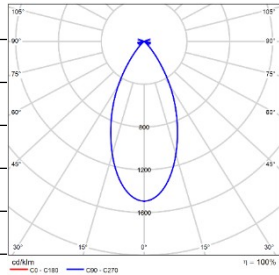
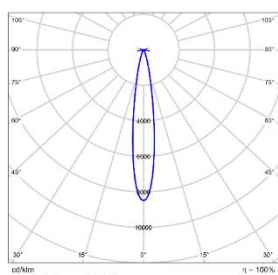
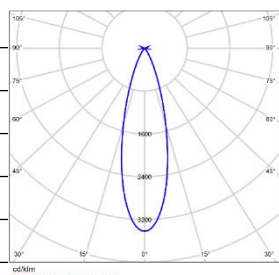
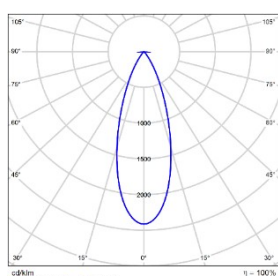
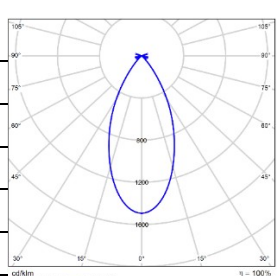
	<p>MODEL : ADDT31-LM07E130SWT</p> <p>ANGLE : 15°</p> <p>POWER : 8W</p> <p>LUMENS: 438lm</p> <p>CBCP: 3725cd</p> <p>EFFICACY: 55lm/W</p>		<p>MODEL: ADDT31-LM07E230SWT</p> <p>ANGLE: 24°</p> <p>POWER: 8W</p> <p>LUMENS: 554lm</p> <p>CBCP: 1894cd</p> <p>EFFICACY: 69lm/W</p>
	<p>MODEL : ADDT31-LM07E330SWT</p> <p>ANGLE : 36°</p> <p>POWER : 8W</p> <p>LUMENS: 456lm</p> <p>CBCP: 1101cd</p> <p>EFFICACY: 57lm/W</p>		<p>MODEL: ADDT31-LM07E530SWT</p> <p>ANGLE : 50°</p> <p>POWER: 8W</p> <p>LUMENS: 378lm</p> <p>CBCP: 565cd</p> <p>EFFICACY: 47lm/W</p>
	<p>MODEL : ADDT31-LM10E130SWT</p> <p>ANGLE : 15°</p> <p>POWER : 11W</p> <p>LUMENS: 542lm</p> <p>CBCP: 4604cd</p> <p>EFFICACY: 49lm/W</p>		<p>MODEL: ADDT31-LM10E230SWT</p> <p>ANGLE: 24°</p> <p>POWER: 11W</p> <p>LUMENS: 685lm</p> <p>CBCP: 2341cd</p> <p>EFFICACY: 62lm/W</p>
	<p>MODEL : ADDT31-LM10E330SWT</p> <p>ANGLE : 36°</p> <p>POWER: 11W</p> <p>LUMENS: 564lm</p> <p>CBCP: 1361cd</p> <p>EFFICACY: 51lm/W</p>		<p>MODEL: ADDT31-LM10E530SWT</p> <p>ANGLE: 50°</p> <p>POWER: 11W</p> <p>LUMENS: 467lm</p> <p>CBCP: 698cd</p> <p>EFFICACY: 42lm/W</p>

3" Round Recessed Adjustable Downlight

PROJECT:

TYPE:

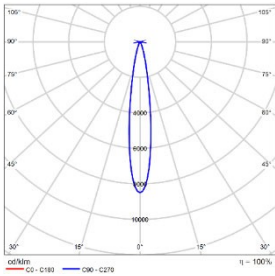

MODEL : ADĐT31-LM13E130SWT
ANGLE : 15°
POWER : 15W
LUMENS: 710lm
CBCP: 6027cd
EFFICACY: 47lm/W

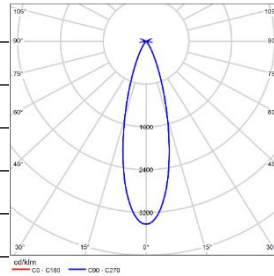

MODEL: ADĐT31-LM13E230SWT
ANGLE: 24°
POWER: 15W
LUMENS: 896lm
CBCP: 3065cd
EFFICACY: 60lm/W

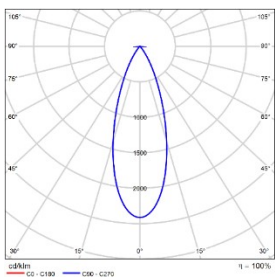

MODEL : ADĐT31-LM13E330SWT
ANGLE : 36°
POWER : 15W
LUMENS: 738lm
CBCP: 1782cd
EFFICACY: 49lm/W

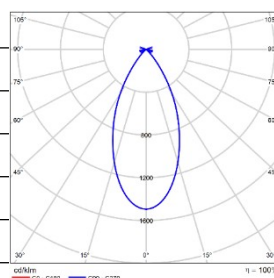

MODEL: ADĐT31-LM13E530SWT
ANGLE: 50°
POWER: 15W
LUMENS: 612lm
CBCP: 914cd
EFFICACY: 41lm/W

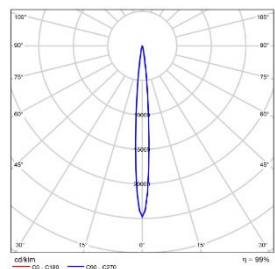

MODEL : ADĐT31-LD08ES30SWT
ANGLE : 8°
POWER: 11W
LUMENS: 375lm
CBCP: 9280cd
EFFICACY: 34lm/W