

**3" Square Narrow Recessed Downlight**

PROJECT:

TYPE:

**Product Image**



**Line Drawing**

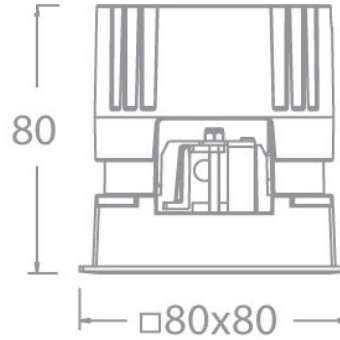

**Product Description**

VOLTA series LED square narrow-edge recessed angle downlights have a streamlined appearance and adopt precise lens and black mirror reflector designs to ensure that the light is emitted while still achieving the ultimate anti-glare effect. The light source cavity adopts a sealed design, which can minimize the impact of humid environment on its performance, and the reflector or optical accessories can be freely disassembled and replaced, which greatly improves on-site convenience and is mainly suitable for hotels and commercial indoor places.

**Product Features**

- Body Material: Aluminum alloy die-casting
- Optical System: Lens+ Reflector
- Finish: Static electricity powder coating
- Adjustable Angle: /
- Accessories: As attached
- Certification: CCC
- IP Rating: IP20
- Insulation Level: Class II
- Operating Temperature: -20°C~40°C

**Product Specifications**

- Cut-out: 75\*75mm
- Ceiling Thickness: 1mm~15mm
- Shielding Angle: 30°
- LED Type: COB
- Source Lm:
  - 2700K: 7W 1065lm; 10W 1425lm; 13W 1855lm
  - 3000K: 7W 1120lm; 10W 1500lm; 13W 1950lm
  - 3500K: 7W 1155lm; 10W 1545lm; 13W 2010lm
  - 4000K: 7W 1200lm; 10W 1605lm; 13W 2085lm
  - 5000K: 7W 1230lm; 10W 1650lm; 13W 2145lm
- LED Lifetime: >50000h-L70 /B10-Ta25°C(LM-80/TM-21)
  - CCT/CRI: 2700K/3000K/3500K/4000K/5000K, CRI≥90
  - Input: 220V AC / 50Hz
  - Dimming: Non dimming/0-10V/DALI
  - Net Weight: 0.35Kg without packing

**Order Model**

Model	Size	Trim	LED	Driver	Beam	CCT	Reflector	Finish
ADLT Downlight T series	3 3"	5 Square Trim	LM07 COB 7W	E On-Off	1 15°	27 2700K	B Black	WT White
			LM10 COB 10W	D 0-10V	2 24°	30 3000K	S Specular	BK Black
			LM13 COB 13W	A DALI	3 36°	35 3500K		
				N No Driver	5 50°	40 4000K 50 5000K		

Example: ADLT35-LM10E230SWT

wacarchitectural.com | WAC Architectural, a WAC GROUP brand.

WAC GROUP Headquarters      WAC Architectural  
44 Harbor Park Drive      Port Washington, NY 11050

3 June 2026 | P.1 of 5

**WAC GROUP**



WAC Group retains the right to modify the design of our products at any time as part of the company's continuous improvement program.

**3" Square Narrow Recessed Downlight**

PROJECT:

TYPE:

**Accessory**

<p><b>ALENS-DLT31-BEL</b> Striped glass lenses</p> 	<p><b>ALENS-DLT31-HCL</b> Edge honeycomb grille</p> 
--	---

Attention: At most one optical accessory can be added, and it is not included in the factory. It needs to be ordered separately.

**LIGHT DISTRIBUTION@3000K LUMINAIRE DATA**

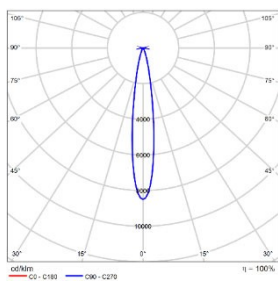
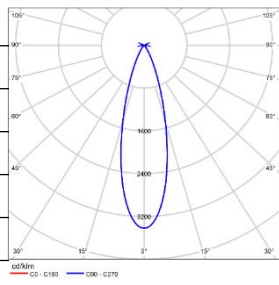
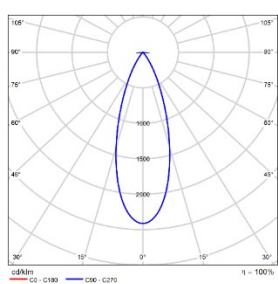
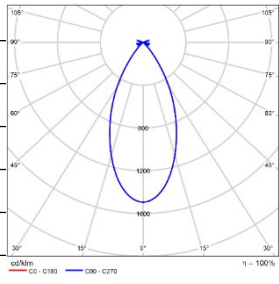
	<p><b>MODEL :</b> ADLT35-LM10E130SWT  <b>ANGLE :</b> 15°  <b>POWER :</b> 10W  <b>LUMENS:</b> 980lm  <b>CBCP:</b> 7141cd  <b>EFFICACY:</b> 98lm/W</p>		<p><b>MODEL:</b> ADLT35-LM10E230SWT  <b>ANGLE:</b> 24°  <b>POWER:</b> 10W  <b>LUMENS:</b> 935lm  <b>CBCP:</b> 4034cd  <b>EFFICACY:</b> 94lm/W</p>
	<p><b>MODEL :</b> ADLT35-LM10E330SWT  <b>ANGLE:</b> 36°  <b>POWER :</b> 10W  <b>LUMENS:</b> 1025lm  <b>CBCP:</b> 2390cd  <b>EFFICACY:</b> 102lm/W</p>		<p><b>MODEL:</b> ADLT35-LM10E530SWT  <b>ANGLE:</b> 50°  <b>POWER:</b> 10W  <b>LUMENS:</b> 877lm  <b>CBCP:</b> 1256cd  <b>EFFICACY:</b> 88lm/W</p>

**4" Square Recessed Adjustable Downlight**

PROJECT:

TYPE:

**Product Image**



**Line Drawing**

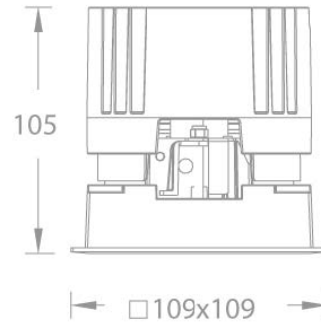

**Product Description**

VOLTA series LED square narrow-edge recessed angle downlights have a streamlined appearance and adopt precise lens and black mirror reflector designs to ensure that the light is emitted while still achieving the ultimate anti-glare effect. The light source cavity adopts a sealed design, which can minimize the impact of humid environment on its performance, and the reflector or optical accessories can be freely disassembled and replaced, which greatly improves on-site convenience and is mainly suitable for hotels and commercial indoor places.

**Product Features**

- Body Material: Aluminum alloy die-casting
- Optical System: Lens+ Reflector
- Finish: Static electricity powder coating
- Adjustable Angle: Vertical 0-25°
- Accessories: As attached
- Certification: CCC
- IP Rating: IP20
- Insulation Level: Class II
- Operating Temperature: -20°C~40°C

**Product Specifications**

- Cut-out: 100\*100mm
- Ceiling Thickness: 1mm~20mm
- Shielding Angle: 30°
- LED Type: COB
- Source Lm:
  - 2700K: 13W 1855lm; 18W 2565lm
  - 3000K: 13W 1950lm; 18W 2700lm
  - 3500K: 13W 2010lm; 18W 2780lm
  - 4000K: 13W 2090lm; 18W 2890lm
  - 5000K: 13W 2145lm; 18W 2970lm
- LED Lifetime: >50000h-L70 /B10-Ta25°C(LM-80/TM-21)
  - CCT/CRI: 2700K/3000K/3500K/4000K/5000K, CRI≥90
  - Input: 220V AC / 50Hz
  - Dimming: No dimming/0-10V/DALI
- Net Weight: 0.7Kg without packing

**4" Square Recessed Adjustable Downlight**

PROJECT:



TYPE:

**Order model**

Model	Size	Trim	LED	Driver	Beam	CCT	Reflector	Finish
ADDT Downlight T series	4 4"	5 Square Trim	LM13 COB 13W	E ON-OFF	N 12°	27 2700K	B Black S Specular	WT White BK Black
			LM18 COB 18W	D 0-10V	1 18°	30 3000K		
			LM18 COB 18W	N No Driver	2 24°	35 3500K		
				A DALI	3 36°	40 4000K		
					5 55°	50 5000K		

Example: ADDT45-LM18E230SWT

**Accessory**

<p><b>ALENS-DLT41-BEL</b> Striped glass lenses</p> 	<p><b>ALENS-DLT41-HCL</b> Borderless honeycomb grille</p> 
--	---

Attention: At most one optical accessory can be added, and it is not included in the factory. It needs to be ordered separately.

**4" Square Recessed Adjustable Downlight**

PROJECT:

TYPE:

**LIGHT DISTRIBUTION@3000K LUMINAIRE DATA**

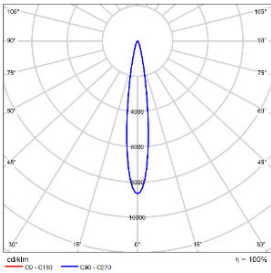

**MODEL :** ADLT45-LM18EN30SWT  
**ANGLE :** 12°  
**POWER :** 18W  
**LUMENS:** 1679lm  
**CBCP:** 19295cd  
**EFFICACY:** 93lm/W

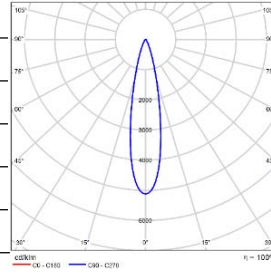

**MODEL:** ADLT45-LM18E130SWT  
**ANGLE:** 18°  
**POWER:** 18W  
**LUMENS:** 2389lm  
**CBCP:** 14373cd  
**EFFICACY:** 133lm/W

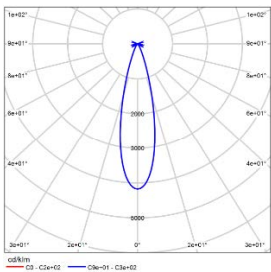

**MODEL :** ADLT45-LM18E230SWT  
**ANGLE :** 24°  
**POWER :** 18W  
**LUMENS:** 2302lm  
**CBCP:** 9023cd  
**EFFICACY:** 128lm/W

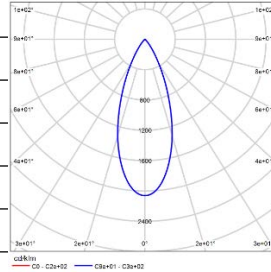

**MODEL:** ADLT45-LM18E330SWT  
**ANGLE :** 36°  
**POWER:** 18W  
**LUMENS:** 2176lm  
**CBCP:** 5323cd  
**EFFICACY:** 121lm/W

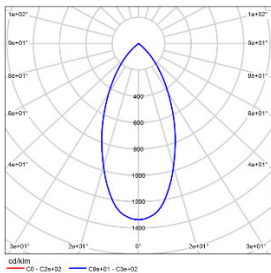

**MODEL :** ADLT45-LM18E530SWT  
**ANGLE :** 55°  
**POWER :** 18W  
**LUMENS:** 2025lm  
**CBCP:** 2781cd  
**EFFICACY:** 112lm/W