

FUEGO PRO- MODEL: AEIS1S

In-ground Luminaires

WAC ARCHITECTURAL

PROJECT:

TYPE:

Product Image



Line Drawing

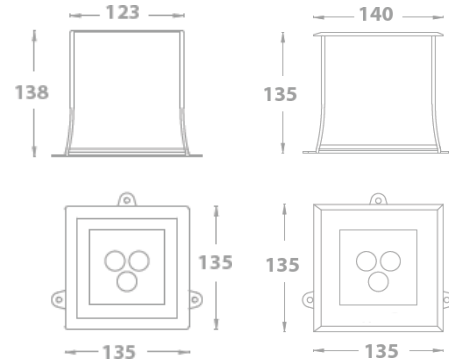

Product Description

The IP67 waterproof design and FUEGO PRO buried lamp are equipped with a patented anti condensation design, featuring symmetrical and asymmetrical wall sweeping and projection light distribution. The unique adjustable device allows for on-site adjustment of the light direction, with an adjustment range of 0 ° to 20 °. There are two types of power supply options available: 24V DC and 220V AC.

Product Features

- Body Material: Aluminum alloy die-casting
- Optical System: Lens
- Finish: Static electricity powder coating
- Adjustable Angle: /
- Accessories: Embedded parts, suction cups, textured glass, honeycomb mesh
- Certification: CCC
- IP Rating: IP67/IK08 (load-bearing capacity 2000Kg)
- Insulation Level: Class III
- Operating Temperature: -20°C~50°C

Product Specifications

- LED Type: High Power
- Power: 7W(Max)
- Source Lm: 3000K 483lm;4000K 513lm
- LED Lifetime: >50000h-L70 /B10-Ta25°C(LM-80/TM-21)
- CCT/CRI: 3000K,Ra80 / 4000K,Ra80
- SDCM: 3 SDCM
- Input: 24V DC or 220V/AC
- Dimming: ON-OFF or DMX512 Dimming control
- Net Weight: 1.1Kg without packing

Order Model

Model	Comment	Power (W)	LEDs (quantity)	Max Lumens (lm)	Control Systems	Beam	CCT	Finish
AEIS1S	T Frameless	07 7(Max)	3	356	ET ON-OFF	S 8°	30 3000K	B Black
					24V/DC Power Supply			
	F Frame				MT DMX512 Dimming	2 25°	40 4000K	S Stainless Steel
					24V/DC Power Supply			
					EL ON-OFF			
					220V/AC Power Supply			

Example: AEIS1ST-07ET-S30-B

FUEGO PRO- MODEL: AEIS1S



In-ground Luminaires

WAC ARCHITECTURAL

PROJECT:

TYPE:

Accessory

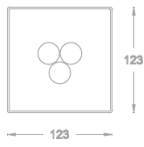
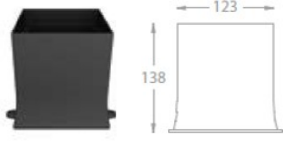
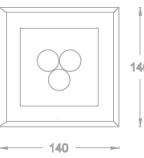
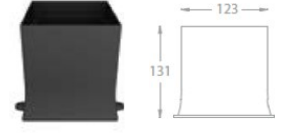
SQUARE	EMBEDEDE PART	SUCTION CUP	BEAM ELONGATOR	HONEYCOMB
Model	EIR1S Series	AEIR1NT-SC001	AEIS1ST-BEL001	AEIS1ST-HCL001
AEIS1ST	AEIS1ST-RC001			
				
AEIS1SF	AEIS1SF-RC001			
				

LIGHT distribution@3000K IUMINAIRE DATA

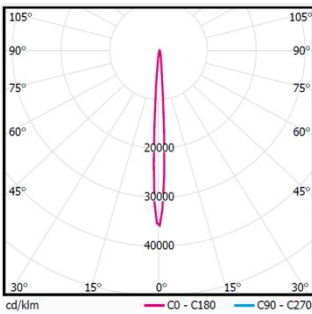

MODEL: AEIS1ST-07EL-S30-B
ANGLE: 8°
POWER: 9.1W
LUMENS: 394lm
CBCP: /
EFFICACY: 43lm/W

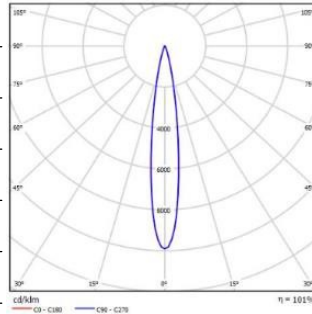

MODEL: AEIS1ST-07EL-130-B
ANGLE: 15°
POWER: 9.2W
LUMENS: 360lm
CBCP: /
EFFICACY: 39lm/W

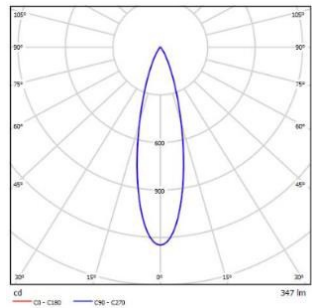

MODEL: AEIS1ST-07EL-230-B
ANGLE: 25°
POWER: 8.7W
LUMENS: 347lm
CBCP: /
EFFICACY: 40lm/W

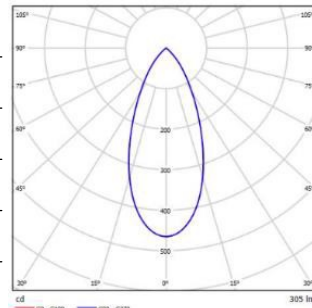

MODEL: AEIS1ST-07EL-430-B
ANGLE: 45°
POWER: 8.7W
LUMENS: 305lm
CBCP: /
EFFICACY: 35lm/W