

VOLTA - MODEL: ADLT25

2" Square Narrow Tunable Recessed Downlight

WAC ARCHITECTURAL

PROJECT:

TYPE:

Product Image



Line Drawing

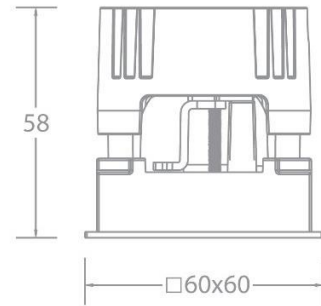

Product Description

VOLTA series LED square narrow-edge recessed downlights have a streamlined appearance and adopt precise lens and black mirror reflector designs to ensure that the light is emitted while still achieving the ultimate anti-glare effect. The light source cavity adopts a sealed design, which can minimize the impact of humid environment on its performance, and the reflector or optical accessories can be freely disassembled and replaced, which greatly improves on-site convenience and is mainly suitable for hotels and commercial indoor places.

Product Features

- Body Material: Aluminum alloy die-casting
- Optical System: Lens+ SUBOROSA optical system
- Finish: Static electricity powder coating
- Adjustable Angle: /
- Accessories: As attached
- Certification: CCC
- IP Rating: IP20(Light source cavity IP44)
- Insulation Level: Class II
- Operating Temperature: -20°C~40°C

Product Specifications

- Cut-out: □55x55mm
- Ceiling Thickness: 1mm~15mm
- Shielding Angle: 30°
- LED Type: COB
- Source Lm: 700 lm
- LED Lifetime: >50000h-L70 /B10-Ta25°C(LM-80/TM-21)
- CCT/CRI: 2700K ~ 6000K, CRI≥Ra90
- Input: 220V AC / 50Hz
- Dimming: DALI
- Net Weight: 0.2Kg without packing

Order Model

Model	Size	Trim	LED	Driver	Beam	CCT	Reflector	Finish
ADLT Downlight T series	2 2"	5 Square Trim	LM07 COB 7W	A DALI N NO DRIVER	2 24°	CC 2700K-6000K (Tunable)	B Black S Specular	WT White BK Black
					3 36°			
					5 50°			

Example: ADLT25-LM07A2CCSWT

wacarchitectural.com | WAC Architectural, a WAC GROUP brand.

WAC GROUP Headquarters
44 Harbor Park Drive
Port Washington, NY 11050

3 June 2026 | P.1 of 4

WAC GROUP

WAC Group retains the right to modify the design of our products at any time as part of the company's continuous improvement program.

VOLTA - MODEL: ADLT25



WAC ARCHITECTURAL

2" Square Tunable Downlight

PROJECT:

TYPE:

Accessories

ALENS-DLT21-BEL Striped glass lens 	ALENS-DLT21-HCL Honeycomb 
--	---

Note: A maximum of one optical accessory can be installed. The accessories are not shipped from the factory and need to be ordered separately.

LIGHT DISTRIBUTION@3000K LUMINAIRE DATA

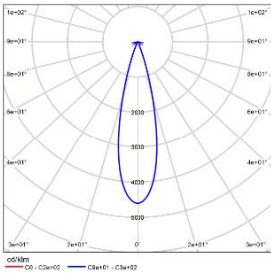

MODEL:	ADLT25-LM07A2CCSWT
BEAM ANGLE:	24°
POWER:	8.4W
LUMENS:	395lm
CBCP:	1992cd
EFFICACY:	47lm/W

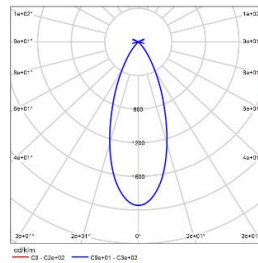

MODEL:	ADLT25-LM07A3CCSWT
BEAM ANGLE:	36°
POWER:	8.4W
LUMENS:	380lm
CBCP:	769cd
EFFICACY:	45lm/W

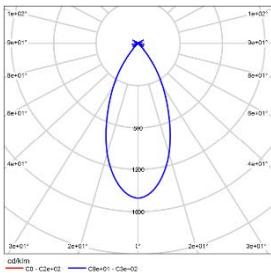

MODEL:	ADLT25-LM07A5CCSWT
BEAM ANGLE:	50°
POWER:	8.4W
LUMENS:	348lm
CBCP:	499cd
EFFICACY:	41lm/W

VOLTA - MODEL: ADLT35

3" Square Narrow Tunable Recessed Downlight

WAC ARCHITECTURAL

PROJECT:

TYPE:

Product Image



Line Drawing

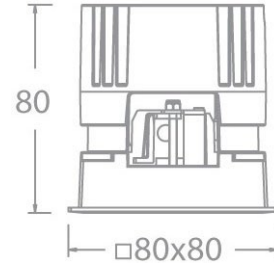

Product Description

VOLTA series LED square narrow-edge recessed downlights have a streamlined appearance and adopt precise lens and black mirror reflector designs to ensure that the light is emitted while still achieving the ultimate anti-glare effect. The light source cavity adopts a sealed design, which can minimize the impact of humid environment on its performance, and the reflector or optical accessories can be freely disassembled and replaced, which greatly improves on-site convenience and is mainly suitable for hotels and commercial indoor places.

Product Features

- Body Material: Aluminum alloy die-casting
- Optical System: Lens+ SUBOROSA optical system
- Finish: Static electricity powder coating
- Adjustable Angle: /
- Accessories: As attached
- Certification: CCC
- IP Rating: IP20(Light source cavity IP44)
- Insulation Level: Class II
- Operating Temperature: -20°C~40°C

Product Specifications

- Cut-out: □75x75mm
- Ceiling Thickness: 1mm~15mm
- Shielding Angle: 30°
- LED Type: COB
- Source Lm: 1300lm
- LED Lifetime: >50000h-L70 /B10-Ta25°C(LM-80/TM-21)
- CCT/CRI: 2700K ~ 6000K, CRI≥Ra90
- Input: 220V AC / 50Hz
- Dimming: DALI
- Net Weight: 0.35Kg without packing

Order Model

Model	Size	Trim	LED	Driver	Beam	CCT	Reflector	Finish
ADLT Downlight T series	3 3"	5 Square Trim	LM13 COB 13W	N NO DRIVER A DALI	1 18°	CC 2700K-6000K (Tunable)	B Black S Specular	WT White BK Black
					2 28°			
					3 36°			
					5 50°			

Example: ADLT35-LM13A2CCSWT

VOLTA - MODEL: ADLT35

WAC ARCHITECTURAL

3" Square Narrow Tunable Recessed Downlight

PROJECT:

TYPE:

Accessories

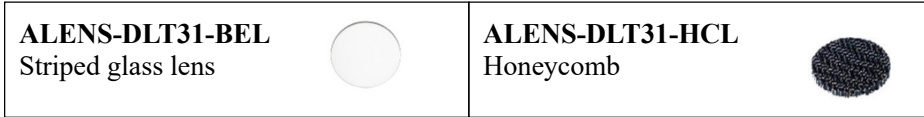

Note: A maximum of one optical accessory can be installed. The accessories are not shipped from the factory and need to be ordered separately.

LIGHT DISTRIBUTION@3000K LUMINAIRE DATA

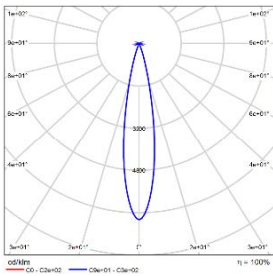

MODEL:	ADLT35-LM13A1CCSWT
BEAM ANGLE:	18°
POWER:	16W
LUMENS:	688lm
CBCP:	4588cd
EFFICACY:	43lm/W

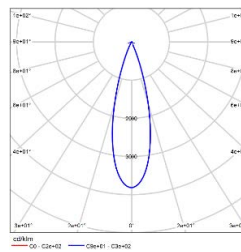

MODEL:	ADLT35-LM13A2CCSWT
BEAM ANGLE:	28°
POWER:	16W
LUMENS:	1042lm
CBCP:	3976cd
EFFICACY:	65lm/W

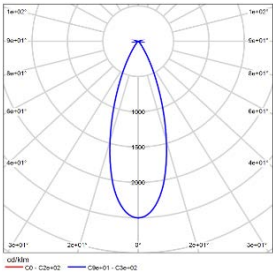

MODEL:	ADLT35-LM13A3CCSWT
BEAM ANGLE:	36°
POWER:	16W
LUMENS:	923lm
CBCP:	2309cd
EFFICACY:	58lm/W

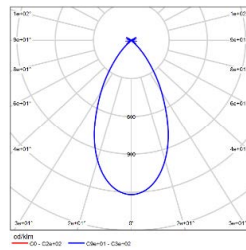

MODEL:	ADLT35-LM13A5CCSWT
BEAM ANGLE:	50°
POWER:	16W
LUMENS:	740lm
CBCP:	902cd
EFFICACY:	46lm/W