

# VOLTA - MODEL: ADDT21

## 2" Round Narrow Tunable Recessed Downlight

WAC ARCHITECTURAL

PROJECT:

TYPE:

### Product Image



### Line Drawing

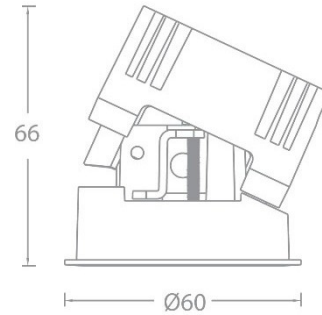

### Product Description

VOLTA Tunable series LED round narrow-edge recessed angle downlights have a streamlined appearance and adopt precise lens and black mirror reflector designs to ensure that the light is emitted while still achieving the ultimate anti-glare effect. The light source cavity adopts a sealed design, which can minimize the impact of humid environment on its performance, and the reflector or optical accessories can be freely disassembled and replaced, which greatly improves on-site convenience and is mainly suitable for hotels and commercial indoor places.

### Product Features

- Body Material: Aluminum alloy die-casting
- Optical System: Lens+ SUBOROSA optical system
- Finish: Static electricity powder coating
- Adjustable Angle: 0-25° tilt
- Accessories: As attached
- Certification: CCC
- IP Rating: IP20(Light source cavity IP44)
- Insulation Level: Class II
- Operating Temperature: -20°C~40°C

### Product Specifications

- Cut-out: Ø55mm
- Ceiling Thickness: 1mm~15mm
- Shielding Angle: 30°
- LED Type: COB
- Source Lm: 700 lm
- LED Lifetime: >50000h-L70 /B10-Ta25°C(LM-80/TM-21)
- CCT/CRI: 2700K~6000K, CRI≥Ra90
- Input: 220V AC / 50Hz
- Dimming: DALI
- Net Weight: 0.2Kg without packing

### Order Model

Model	Size	Trim	LED	Driver	Beam	CCT	Reflector	Finish
<b>ADDT</b> Downlight Directional T series	2	1	<b>LM07</b> COB 7W	N NO DRIVER A DALI	2 24°	CC 2700K-6000K (Tunable)	B Black S Specular	WT White BK Black
	2"	Round Trim			3 36°			
					5 50°			

Example: ADDT21-LM07A2CCSWT

wacarchitectural.com | WAC Architectural, a WAC GROUP brand.

WAC GROUP Headquarters  
44 Harbor Park Drive  
Port Washington, NY 11050

3 June 2026 | P .1 of 4

WAC GROUP

WAC Group retains the right to modify the design of our products at any time as part of the company's continuous improvement program.

# VOLTA - MODEL: ADDT21



## 2" Round Narrow Tunable Recessed Downlight

WAC ARCHITECTURAL

PROJECT:

TYPE:

### Accessories

<b>ALENS-DLT21-BEL</b> Striped glass lens 	<b>ALENS-DLT21-HCL</b> Honeycomb 
--	---

Note: A maximum of one optical accessory can be installed. The accessories are not shipped from the factory and need to be ordered separately.

### LIGHT DISTRIBUTION@3000K LUMINAIRE DATA

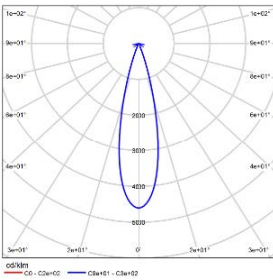

<b>MODEL:</b>	ADDT21-LM07A2CCSWT
<b>BEAM ANGLE:</b>	24°
<b>POWER:</b>	8.4W
<b>LUMENS:</b>	395lm
<b>CBCP:</b>	1992cd
<b>EFFICACY:</b>	47lm/W

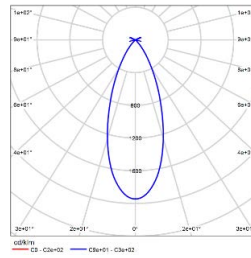

<b>MODEL:</b>	ADDT21-LM07A3CCSWT
<b>BEAM ANGLE:</b>	36°
<b>POWER:</b>	8.4W
<b>LUMENS:</b>	380lm
<b>CBCP:</b>	769cd
<b>EFFICACY:</b>	45lm/W

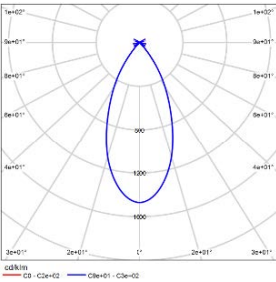

<b>MODEL:</b>	ADDT21-LM07A5CCSWT
<b>BEAM ANGLE:</b>	50°
<b>POWER:</b>	8.4W
<b>LUMENS:</b>	348lm
<b>CBCP:</b>	499cd
<b>EFFICACY:</b>	41lm/W

# VOLTA - MODEL: ADDT31

## 3" Round Narrow Tunable Recessed Downlight

WAC ARCHITECTURAL

PROJECT:

TYPE:

### Product Image



### Line Drawing

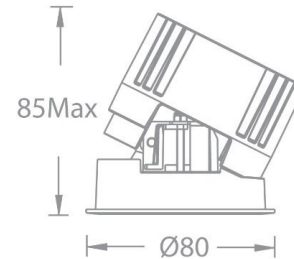

### Product Description

VOLTA series LED round narrow-edge recessed angle downlights have a streamlined appearance and adopt precise lens and black mirror reflector designs to ensure that the light is emitted while still achieving the ultimate anti-glare effect. The light source cavity adopts a sealed design, which can minimize the impact of humid environment on its performance, and the reflector or optical accessories can be freely disassembled and replaced, which greatly improves on-site convenience and is mainly suitable for hotels and commercial indoor places.

### Product Features

- Body Material: Aluminum alloy die-casting
- Optical System: Lens+ SUBOROSA optical system
- Finish: Static electricity powder coating
- Adjustable Angle: 0-25° tilt
- Accessories: As attached
- Certification: CCC
- IP Rating: IP20(Light source cavity IP44)
- Insulation Level: Class II
- Operating Temperature: -20°C~40°C

### Product Specifications

- Cut-out: Ø75mm
- Ceiling Thickness: 1mm~15mm
- Shielding Angle: 30°
- LED Type: COB
- Source Lm: 1300lm
- LED Lifetime: >50000h-L70 /B10-Ta25°C(LM-80/TM-21)
- CCT/CRI: 2700K ~ 6000K, CRI≥Ra90
- Input: 220V AC / 50Hz
- Dimming: DALI
- Net Weight: 0.35Kg without packing

### Order Model

Model	Size	Trim	LED	Driver	Beam	CCT	Reflector	Finish
<b>ADDT</b>					<b>1</b> 18°	<b>CC</b> 2700K-6000K (Tunable)	<b>B</b> Black <b>S</b> Specular	<b>WT</b> White <b>BK</b> Black
Downlight	<b>3</b>	<b>1</b>	<b>LM13</b> COB 13W	<b>N</b> NO DRIVER	<b>2</b> 28°			
Directional	3"	Round Trim		<b>A</b> DALI	<b>3</b> 36°			
T series					<b>5</b> 50°			

Example: ADDT31-LM13A2CCSWT

# VOLTA - MODEL: ADDT31



WAC ARCHITECTURAL

## 3" Round Narrow Tunable Recessed Downlight

PROJECT:

TYPE:

### Accessories

<b>ALENS-DLT31-BEL</b> Striped glass lens 	<b>ALENS-DLT31-HCL</b> Honeycomb 
--	---

Note: A maximum of one optical accessory can be installed. The accessories are not shipped from the factory and need to be ordered separately.

### LIGHT DISTRIBUTION@3000K LUMINAIRE DATA

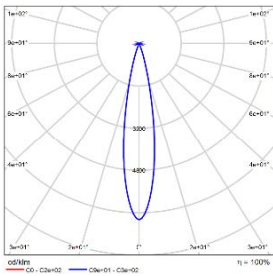

<b>MODEL:</b>	ADDT31-LM13A1CCSWT
<b>BEAM ANGLE:</b>	18°
<b>POWER:</b>	16W
<b>LUMENS:</b>	688lm
<b>CBCP:</b>	4588cd
<b>EFFICACY:</b>	43lm/W

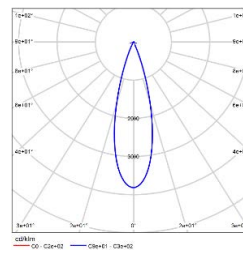

<b>MODEL:</b>	ADDT31-LM13A2CCSWT
<b>BEAM ANGLE:</b>	28°
<b>POWER:</b>	16W
<b>LUMENS:</b>	1042lm
<b>CBCP:</b>	3976cd
<b>EFFICACY:</b>	65lm/W

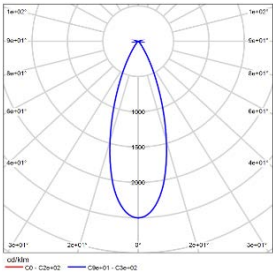

<b>MODEL:</b>	ADDT31-LM13A3CCSWT
<b>BEAM ANGLE:</b>	36°
<b>POWER:</b>	16W
<b>LUMENS:</b>	923lm
<b>CBCP:</b>	23091cd
<b>EFFICACY:</b>	58lm/W

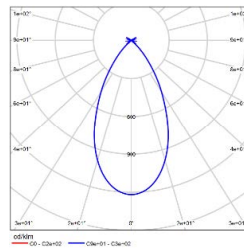

<b>MODEL:</b>	ADDT31-LM13A5CCSWT
<b>BEAM ANGLE:</b>	50°
<b>POWER:</b>	16W
<b>LUMENS:</b>	740lm
<b>CBCP:</b>	902cd
<b>EFFICACY:</b>	46lm/W