

# VOLTA - MODEL: ADLT01

## Recessed Ceiling Luminaires

WAC ARCHITECTURAL

PROJECT:

TYPE:

Product Image



Line Drawing

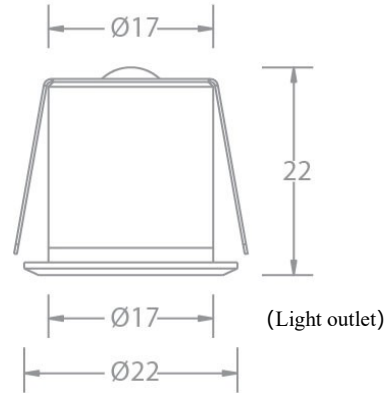

### DESCRIPTION

The VOLTA series mini down lighting tube lamp has a simple appearance and exquisite dimensions; Using a lens for light distribution, it has a precise light angle and an ultimate anti glare effect. Can be applied to hotels, commercial public spaces, and other places.

### Product Features

- Body Material: Aluminum alloy die-casting
- Optical System: Lens
- Finish: Static electricity powder coating
- Adjustable Angle: /
- Accessories: Equipped with honeycomb (17°、24°、36°)
- Certification: CCC
- IP Rating: IP20
- Insulation Level: Class II
- Operating Temperature: -20°C~40°C

### Product Specifications

- Cut-out: Ø18mm
- Ceiling Thickness: 1mm~15mm
- Shielding Angle: 15°
- LED Type: HP LED
- Source Lm: 3000K 100lm; 4000K 110lm;
- LED Lifetime: >50000h-L70 /B10-Ta25°C(LM-80/TM-21)
- CCT/CRI: 2700K/ 3000K/3500K/4000K, Ra90
- SDCM: 3 SDCM
- Input: 24V DC
- Dimming: DMX512(24V)
- Net Weight: 0.01Kg , without packing

### Ordering Model

Model	Size	Trim	LED	Driver	Beam	CCT	Reflector	Finish
ADLT Downlight Directional T series	0 0.5"	1 Round Trim	LD01 LED 1W	T DMX512(24VDC)	1 17°	27 2700K	W White	WT White
				M MTB *	2 24°	30 3000K		
				N No Driver	3 36°	35 3500K	B Black	BK Black
					6 60°	40 4000K		

Example: ADLT01-LD01N230WWT

Note: Except for 60°, all other products come with their own honeycomb when leaving the factory. AMTB needs to be ordered separately and cannot be directly connected to the mains. (AMTB: <https://www.wacighting.com.cn/product-detail/300>)

wacarchitectural.com | WAC Architectural, a WAC GROUP brand.

WAC GROUP Headquarters WAC Architectural  
44 Harbor Park Drive Port Washington, NY 11050

3 June 2026 | P.1 of 6

WAC GROUP

WAC Group retains the right to modify the design of our products at any time as part of the company's continuous improvement program.

# VOLTA - MODEL: ADLT01

## Recessed Ceiling Luminaires

WAC ARCHITECTURAL

PROJECT:

TYPE:

### Accessory

/

### LIGHT DISTRIBUTION@3000K LUMINAIRE DATA

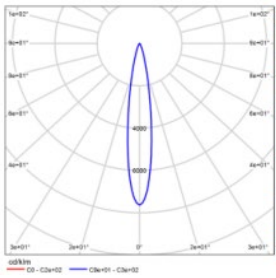

**MODEL:** ADLT01-LD01T130WWT

**BEAM ANGLE:** 17°

**POWER:** 1.5W

**LUMENS:** 41lm

**CBCP:** 271cd

**EFFICACY:** 27lm/W

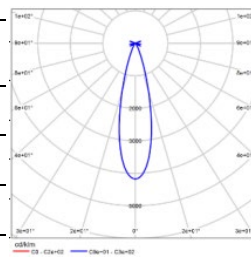

**MODEL:** ADLT01-LD01T230WWT

**BEAM ANGLE:** 24°

**POWER:** 1.5W

**LUMENS:** 455lm

**CBCP:** 178cd

**EFFICACY:** 25lm/W

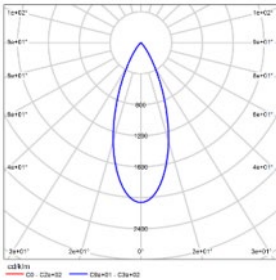

**MODEL:** ADLT01-LD01T330WWT

**BEAM ANGLE:** 36°

**POWER:** 1.5W

**LUMENS:** 27lm

**CBCP:** 53cd

**EFFICACY:** 18lm/W

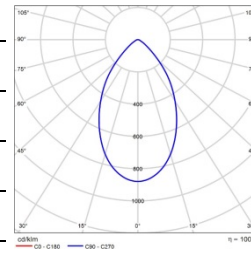

**MODEL:** ADLT01-LD01T630WWT

**BEAM ANGLE:** 60°

**POWER:** 1.5W

**LUMENS:** 63lm

**CBCP:** 55cd

**EFFICACY:** 42lm/W

# VOLTA - MODEL: ADLT11

## Recessed Ceiling Luminaires

WAC ARCHITECTURAL

PROJECT:

TYPE:

### Product Image



### Line Drawing

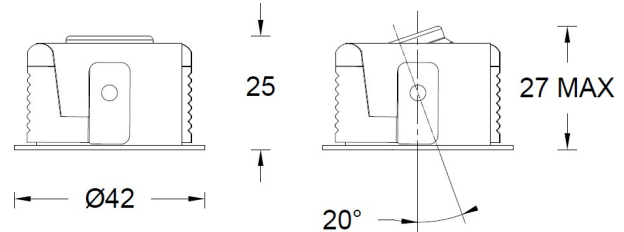

### DESCRIPTION

The VOLTA series LED circular narrow edge embedded tube light has a simple appearance and exquisite size, which can be used for lighting or angle adjustment. Adopting a lens + honeycomb light distribution, it has a precise light angle and an ultimate anti glare effect. Can be applied to hotels, commercial public spaces, and other places.

### Product Features

- Body Material: Aluminum alloy die-casting
- Optical System: Lens
- Finish: Static electricity powder coating
- Adjustable Angle: Horizontal 0~360°, vertical -20°~20°
- Accessories: Equipped with honeycomb
- Certification: CCC
- IP Rating: IP20
- Insulation Level: Class II
- Operating Temperature: -20°C~40°C

### Product Specifications

- Cut-out: Ø36mm
- Ceiling Thickness: 1mm~15mm
- Shielding Angle: 15°
- LED Type: HP LED
- Source Lm: 2700K 170lm; 3000K 175lm; 4000K 185lm;
- LED Lifetime: >50000h-L70 /B10-Ta25°C(LM-80/TM-21)
- CCT/CRI: 2700K/ 3000K/4000K, Ra90
- SDCM: 3 SDCM
- Input: 220V-240V AC /50Hz
- Dimming: /
- Net Weight: 0.1Kg, without packing

### Ordering Model

Model	Size	Trim	LED	Driver	Beam	CCT	Reflector	Finish
ADDT Downlight Directional T series	1 1"	1 Round Trim	LD02 LED 2W	E On-Off No N Driver	1 12°	27 2700K	W White	WT White
					2 24°	30 3000K		
					3 36°	35 3500K		
					5 55°	40 4000K		
						B Black	BK Black	

Example: ADDP11-LD02E230WWT

wacarchitectural.com | WAC Architectural, a WAC GROUP brand.

WAC GROUP Headquarters  
44 Harbor Park Drive  
Port Washington, NY 11050

3 June 2026 | P.3 of 6

WAC GROUP

WAC Group retains the right to modify the design of our products at any time as part of the company's continuous improvement program.

# VOLTA - MODEL: ADLT11

## Recessed Ceiling Luminaires

WAC ARCHITECTURAL

PROJECT:

TYPE:

### Accessory

/

### LIGHT DISTRIBUTION@3000K LUMINAIRE DATA

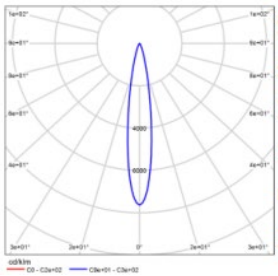

**MODEL:** ADDT11-LD02E130WWT  
**BEAM ANGLE:** 12°  
**POWER:** 4W  
**LUMENS:** 91lm  
**CBCP:** 1122cd  
**EFFICACY:** 23lm/W

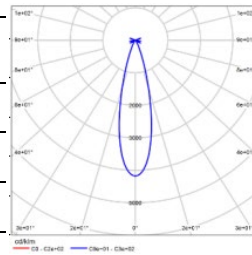

**MODEL:** ADDT11-LD02E230WWT  
**BEAM ANGLE:** 24°  
**POWER:** 4W  
**LUMENS:** 95lm  
**CBCP:** 390cd  
**EFFICACY:** 24lm/W

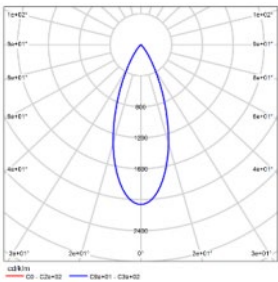

**MODEL:** ADDT11-LD02E330WWT  
**BEAM ANGLE:** 36°  
**POWER:** 4W  
**LUMENS:** 89lm  
**CBCP:** 211cd  
**EFFICACY:** 22lm/W

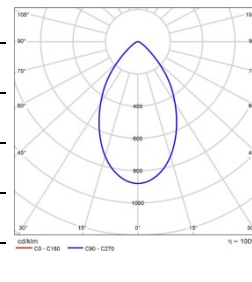

**MODEL:** ADDT11-LD02E530WWT  
**BEAM ANGLE:** 55°  
**POWER:** 4W  
**LUMENS:** 74lm  
**CBCP:** 88cd  
**EFFICACY:** 19lm/W

# VOLTA- MODEL: ADDT11

## Recessed Ceiling Adjustable Luminaires

WAC ARCHITECTURAL

PROJECT:

TYPE:

### Product Image



### Line Drawing

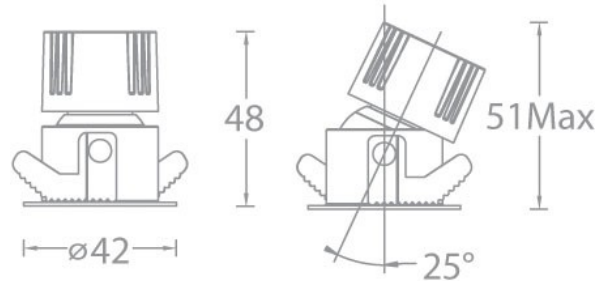

### DESCRIPTION

The VOLTA series LED circular narrow edge embedded tube light has a simple appearance and exquisite size, which can be used for lighting or angle adjustment. Adopting a lens + honeycomb light distribution, it has a precise light angle and an ultimate anti glare effect. Can be applied to hotels, commercial public spaces, and other places.

### Product Features

- Body Material: Aluminum alloy die-casting
- Optical System: Lens+ honeycomb
- Finish: Static electricity powder coating
- Adjustable Angle: Vertical 0-25 ° adjustment
- Accessories: Equipped with honeycomb
- Certification: CCC
- IP Rating: IP20
- Insulation Level: Class II
- Operating Temperature: -20°C~40°C

### Product Specifications

- Cut-out: Ø36mm
- Ceiling Thickness: 1mm~15mm
- Shielding Angle: 15°
- LED Type: HP LED
- Source Lm: 2700K 474lm; 3000K 500lm; 3500K 522lm; 4000K 531lm; 5000K 538lm;
- LED Lifetime: >50000h-L70 /B10-Ta25°C(LM-80/TM-21)
- CCT/CRI: 2700K/ 3000K/3500K/ 4000K/4000K,Ra90
- Input: 220V AC /50Hz
- Dimming: Non dimming/0-10V/DALI (must undergo compatibility testing with the project site system in advance)
- Net Weight: 0.1Kg , without packing

### Ordering model

Model	Size	Trim	LED	Driver	Beam	CCT	Reflector	Finish
ADDT	1	1	LD05 LED 5W	E On-Off	1 15°	27 2700K	WT White	WT White
Downlight	1"	Round Trim		D 0-10V Dimming	2 24°	30 3000K		
Directional				A DALI	3 36°	35 3500K	BK Black	BK Black
T series				N No Driver	5 50°	40 4000K		
						50 5000K		

Example: ADDT11-LD05E230WWT

wacarchitectural.com | WAC Architectural, a WAC GROUP brand.

WAC GROUP Headquarters 44 Harbor Park Drive  
WAC Architectural Port Washington, NY 11050

3 June 2026 | P .5 of 6

WAC GROUP

WAC Group retains the right to modify the design of our products at any time as part of the company's continuous improvement program.

**VOLTA- MODEL: ADDT11**  
 Recessed Ceiling Adjustable Luminaires

**WAC ARCHITECTURAL**

PROJECT:

TYPE:

**Accessory**

/

**LIGHT DISTRIBUTION@3000K LUMINAIRE DATA**

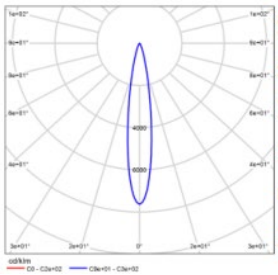

**MODEL:** ADDT11-LD05E130SWT  
**BEAM ANGLE:** 15°  
**POWER:** 5.5W  
**LUMENS:** 274lm  
**CBCP:** 2185cd  
**EFFICACY:** 50lm/W

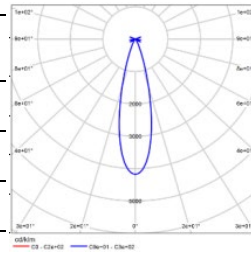

**MODEL:** ADDT11-LD05E230SWT  
**BEAM ANGLE:** 24°  
**POWER:** 5.5W  
**LUMENS:** 235lm  
**CBCP:** 914cd  
**EFFICACY:** 43lm/W

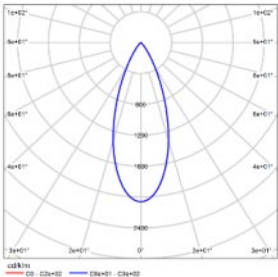

**MODEL:** ADDT11-LD05E330SWT  
**BEAM ANGLE:** 36°  
**POWER:** 5.5W  
**LUMENS:** 218lm  
**CBCP:** 477cd  
**EFFICACY:** 40lm/W

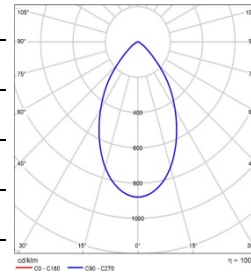

**MODEL:** ADDT11-LD05E530SWT  
**BEAM ANGLE:** 50°  
**POWER:** 5.5W  
**LUMENS:** 184lm  
**CBCP:** 281cd  
**EFFICACY:** 33lm/W